

ZGM-6-5H | ZGHSA | ZGCM-48 | ZGCM-66 | ZGCM-HSA

## **Floor & Ceiling Mounted Units**

**Table of Contents**

**Important Information** ..... 5

    Read this Manual Before Starting to Work! ..... 5

    Zero-Gravity Document List ..... 5

    Use Instructions ..... 6

    Intended Use ..... 7

        Zero-Gravity® Radiation Protection System ..... 7

    Key Operational Characteristics ..... 7

    Foreseeable Misuse ..... 7

    Safety Liability ..... 7

    Safety Warning ..... 8

    User's Guide ..... 8

**System Description** ..... 9

    Zero-Gravity Floor Unit (ZGM-6-5H) ..... 9

    Zero-Gravity Hinged Swing Arm Unit (ZGHSA) ..... 9

    Zero-Gravity Monorail Hinged Swing Arm (ZGCM-HSA) ..... 10

    Zero-Gravity Monorail Unit (ZGCM-48 or ZGCM-66) ..... 10

**Safety Symbols** ..... 11

    Document Safety Symbols ..... 12

    Device Safety Symbols ..... 15

    Device Operation Symbols ..... 17

**Body Shield Overview** ..... 19

    Figure 1 ..... 19

    Figure 1 Chart ..... 20

**System Overview** ..... 21

    Figure 2 (ZGM-6-5H) ..... 21

    Figure 2 Chart (ZGM-6-5H) ..... 22

    Figure 2 Chart (ZGM-6-5H) ..... 23

    Figure 2 – Other Considerations (ZGM-6-5H) ..... 24

    Figure 3 (ZGHSA) ..... 25

    Figure 3 Chart (ZGHSA) ..... 26

    Figure 3 Chart (ZGHSA) ..... 27

    Figure 3 – Other Considerations (ZGHSA) ..... 27

    Figure 4 (ZGCM-48 | ZGCM-66) ..... 28

    Figure 4 Chart (ZGCM-48 | ZGCM-66) ..... 29

    Figure 4 Chart (ZGCM-48 | ZGCM-66) ..... 30

    Figure 4 – Other Considerations (ZGCM-48 | ZGCM-66) ..... 31

    Figure 5 (ZGCM-HSA) ..... 32

    Figure 5 Chart (ZGCM-HSA) ..... 33

    Figure 5 Chart (ZGCM-HSA) ..... 34

    Figure 5 – Other Considerations (ZGCM-HSA) ..... 35

**Using the System** ..... 36

    Position Zero-Gravity Floor Unit in the Procedure Room (ZGM-6-5H) ..... 36

    Position Hinged Swing / Boom Arm Assembly (ZGHSA | ZGCM-48 | ZGCM-66 | ZGCM-HSA) ..... 36

    Level the Base (ZGM-6-5H) ..... 37

        Figure 6 ..... 37

Figure 7 .....	37
Figure 8 .....	38
Set the Height (ZGM-6-5H) .....	39
Figure 9 .....	39
Two Devices Must Be Disengaged To Position The Vertical Column For Adjustment (Figure 9) .....	39
To Unlock The Vertical Column For Adjustment .....	40
Figure 10 .....	40
Figure 11 .....	41
Figure 12 .....	42
The Lock Pin Is Engaged When The Pin Is Moved Completely Inside The Slot (Figure 12) .....	42
Figure 13 .....	43
Lock the Boom Arm (ZGM-6-5H) .....	44
Figure 14 .....	44
To Lock The Boom Arm (Figure 14) .....	44
Figure 15 .....	45
To Unlock The Boom Arm (Figure 15) .....	45
Adjust Boom Arm Angle (ZGCM-48   ZGCM-66) .....	46
Figure 16 .....	46
Figure 17 .....	47
Figure 18 .....	48
Maneuver the Boom Arm Assembly (ZGCM-HSA) .....	49
Figure 19 .....	49
Figure 20 .....	49
To Adjust The Length Of The Handle (Figure 20) .....	49
Lock Docking Station on Boom Arm (All Models) .....	50
Figure 21 .....	50
To Lock The Body Shield In Place (Figure 21) .....	51
To Undock The Balancer (Figure 21) .....	51
To Rotate The Docking Station (Figure 21) .....	51
Secure the Body Shield (All Models) .....	52
Figure 22 .....	52
To Secure The Body Shield Into The Balancer (Figure 22) .....	52
Figure 23 .....	53
To Allow The Body Shield And Balancer Connector To Move As Needed For Use (Figure 23) ...	53
Put Sterile Cover on Body Shield (All Models) .....	54
Fit User Vest (All Models) .....	54
Figure 24 .....	54
To Properly Fit A Vest To Your Body (Figure 24): .....	55
Adjust Body and Face Shield Height (All Models) .....	55
Figure 25 .....	55
To Adjust Body Shield Height (Figure 25) .....	55
Connect Vest to Body Shield (All Models) .....	56
Figure 26 .....	56
To Connect The Vest And The Body Shield (Figure 26) .....	56
To Exit Body Shield (All Models) .....	57
When Not in Use (All Models) .....	57
Disposal (All Models) .....	57
<b>Other Useful Tips</b> .....	58
Moving the Floor Unit .....	58
Within the Surgical Suite or to Other Rooms .....	58

# Zero-Gravity® Radiation Protection System User's Guide

<b>Cleaning the System</b> .....	59
Face Shield .....	59
Microfiber Towels With .....	59
Do Not Use .....	59
Body Shield .....	60
Vest .....	60
Hardware .....	60
<b>Adjusting and Maintaining Zero-Gravity</b> .....	61
Adjust Balancer .....	61
Balancer Safety .....	61
Figure 27 .....	61
Maintenance .....	62
Body Shield and Face Shield Fluoroscopy Inspection .....	62
Available Spare Parts and Accessories .....	63
Tool Pouch .....	64
<b>Limited Warranty</b> .....	64
<b>Declarations of Conformity</b> .....	64
<b>Index of Additional System Labels</b> .....	66
Body Shield Labels .....	66
Vest Labels .....	67
Vest Labels (cont.) .....	68
<b>User's Guide Final Acceptance</b> .....	70
<b>User's Guide Review</b> .....	74

Translations available on the TIDI Products website: <https://www.tidiproducts.com/ifu>

Oversættelser kan findes på TIDI Products' websted: <https://www.tidiproducts.com/ifu>

Vertalingen beschikbaar op de website van TIDI Products: <https://www.tidiproducts.com/ifu>

Traductions disponibles sur le site Web de TIDI Products : <https://www.tidiproducts.com/ifu>

Übersetzungen sind auf der Website von TIDI Products verfügbar: <https://www.tidiproducts.com/ifu>

Traduzioni disponibili sul sito web di TIDI Products: <https://www.tidiproducts.com/ifu>

Tłumaczenia są dostępne w witrynie internetowej firmy TIDI Products: <https://www.tidiproducts.com/ifu>

Traduções disponíveis no site dos Produtos TIDI: <https://www.tidiproducts.com/ifu>

Traducciones disponibles en el sitio web de TIDI Products: <https://www.tidiproducts.com/ifu>

## Important Information

---

### Read this Manual Before Starting to Work!

This information is necessary for the safe and efficient operation of the equipment.

This document should be stored with, or in the immediate vicinity, of the unit.

### Zero-Gravity Document List

- 81000 – Preventative Maintenance Checklist
- 82000 – Uncrating Guide
- 83000 – Installation Guide
- 84000 – User's Guide

Zero-Gravity® Radiation Protection System is a registered trademark of TIDI Products, Inc.

United States Patents 7,973,299; 8,207,516; 8,558,204; 8,598,554 B2; 8,925,553; 8,933,426

For U.S. and Foreign Patent information, see [//go.tidiproducts.com/patents](http://go.tidiproducts.com/patents) Additional Patents Pending

The contents of this publication may not be reproduced, copied, or translated in whole or in part without prior consent from TIDI Products.

Pursuant to continuous product improvement, TIDI Products reserves the right to change the equipment design and technology at any time.

All rights under the copyright laws are expressly reserved by TIDI Products.

Within the bounds of the legal requirements, the manufacturer is only responsible for the technical safety characteristics of this apparatus if the maintenance, repairs, and modifications to this apparatus are performed by TIDI Products or an approved TIDI Products representative.

The Zero-Gravity® Radiation Protection System can also be referred to as Zero-Gravity or Zero-Gravity System.

The Zero-Gravity® Radiation Protection System is available in the following options:

- Floor Unit (ZGM-6-5H)**
- Monorail (ZGCM-48 and ZGCM-66)**
- Hinged Swing Arm (ZGHSA)**
- Monorail Hinged Swing Arm (ZGCM-HSA)**

**This guide applies to Zero-Gravity Systems manufactured after November 2019. For models prior to November 2019, some features may not apply. Contact TIDI Products service for additional information.**

## Use Instructions

The use instructions in this document refer to the Zero-Gravity® Radiation Protection System with the following identification:

- **Manufactured for:** TIDI Products, LLC
- **Product name:** Zero-Gravity® Radiation Protection System
- **Type designation:** Floor Unit (ZGM-6-5H), Hinged Swing Arm (ZGHSA), Monorail Hinged Swing Arm (ZGCM- HSA), Monorail 48 (ZGCM-48) or 66 inches (ZGCM-66)
- **Serial Number:** See Identification Tag (Figure 2, 3, 4, & 5)
- **Sterile covers manufactured by:** TIDI Products
- **Authorized representatives:** See Declarations of Conformity.
- **Manufacture date:** See Identification Tag (Figure 2, 3, 4, & 5)
- Conforms to Annex II, Personal Protective Equipment (EU) Regulation 2016/425 Category III, and as brought into UK law and amended.



**Manufactured for:**  
TIDI Products, LLC  
570 Enterprise Drive  
Neenah, WI 54956 USA  
  
Phone: 1.800.521.1314  
+1.920.751.4300  
  
[www.tidiproducts.com](http://www.tidiproducts.com)

**CE**<sub>2797</sub>

**NOTIFIED BODY**

BSI Group The Netherlands B.V.  
Say Building  
1066 EP Amsterdam The  
Netherlands

**UK**  
**CA0086**

**APPROVED BODY**

BSI Assurance UK Ltd  
Kitemark Court,  
Davy Avenue Knowlhill  
Milton Keynes, MK5 8PP UK

## Intended Use

### *Zero-Gravity® Radiation Protection System*

A protective shield for use during medical procedures requiring fluoroscopy, intended to protect users from radiation exposure and orthopedic strain. A disposable sterile cover is placed over the protective shield to maintain sterility.

The intended range of motion accommodates the full length of a patient, allows the user to rotate 360°, and includes limited vertical movement, such as tilting and bending.

This system is for indoor use only and must not be subjected to weathering, ultraviolet radiation, or corrosive environments. The defined working and storage environment is a clinical or hospital surgical suite with a temperature range from 50°Fahrenheit (10° Celsius) to 95°Fahrenheit (35° Celsius) with 20% to 75% non-condensing humidity.

## Key Operational Characteristics

- Provides frontal and side radiation exposure protection to Proximal Arm, Axilla, Torso, Gonads, Proximal leg – up to Tibia, Neck and Cranium when set to correct height.
- Body shield is sterile when properly draped by a Zero-Gravity® brand drape.
- Balancer, bearings, and boom operate freely and smoothly throughout range of motion.
- Balancer vertical travel operates freely and smoothly throughout range of motion.
- Body shield does not drift up or down when balanced.
- Body shield and operator maintain connection during use.
- Body Shield easily locks and unlocks to Balancer to steer during positioning.

## Foreseeable Misuse

**Zero-Gravity® Radiation Protection System** has risk and other foreseeable misuse conditions that are identified in the **Safety Symbols** section of this document. Please read this document in its entirety before using this equipment.

## Safety Liability

TIDI Products assumes no liability for the safe and reliable operation of Zero- Gravity® Radiation Protection System where:

- Installation, modifications, or repairs are not performed by TIDI Products technicians or people authorized by TIDI Products.
- Authorized TIDI Products replacement parts are not used.
- Authorized TIDI Products sterility protection accessories are not used.
- The Zero-Gravity has not been installed or setup for a procedure in accordance with the Installation Guide (TIDI Products document 83000) or this document.
- The Zero-Gravity is used in a manner other than its intended use as stated above.

## Safety Warning

- Repairs may only be performed by TIDI Products authorized personnel.
- The weight of Body Shield assembly suspended on the Balancer must not be altered in any way.
- A thorough inspection of equipment should be performed, after each service call, prior to releasing the equipment for use.



### **WARNING!**

To reduce risk of injury, user(s) must carefully read and understand this document and be trained prior to use.

## User's Guide

This document is intended to provide guidance for the proper and safe use of Zero-Gravity system and is used to train personnel.

- It is essential that users read this document, in its entirety, with special consideration to keywords and symbols.
- *Particularly helpful information is italicized.*
- *Personnel removing equipment from the crate should refer to TIDI Products document 82000 (Uncrating Instructions).*
- *Installers should refer to TIDI Products document 83000 (Installation Guide).*
- *Users should refer to TIDI Products document 84000 (User's Guide).*
- *For additional information contact TIDI Products service at +1.920.751.4300.*



## System Description

---

### Zero-Gravity Floor Unit (ZGM-6-5H)

Features: Mobile unit with heavy base with casters and locks, variable-height mast, 48" pivoting boom.



### Zero-Gravity Hinged Swing Arm Unit (ZGHSA)

Features: Ceiling mounted central pivot-plate, swinging rigid arm, 48" lower track.



## Zero-Gravity Monorail Hinged Swing Arm (ZGCM-HSA)

Features: Ceiling mounted upper track, central pivot on upper trolley with 48" lower track.

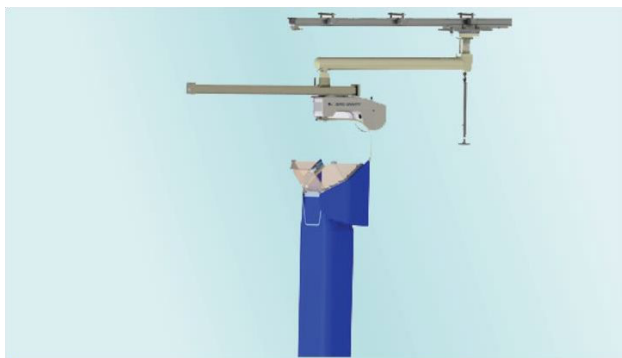

## Zero-Gravity Monorail Unit (ZGCM-48 or ZGCM-66)

Features: Ceiling mounted upper track, (ZGCM-48) 48" lower track or (ZGCM-66) 66" lower track.



## Safety Symbols

Important information in this document is marked with symbols and keywords. Keywords such as **WARNING**, **CAUTION**, or **ATTENTION** indicate the level of risk involved. The symbols emphasize the message visually.

	<p><b>WARNING!</b></p> <p>Indicates a potentially hazardous situation, which could result in a serious risk of injury or death to patient or operator and or damage to equipment or property.</p>
	<p><b>CAUTION!</b></p> <p>Indicates a potentially hazardous situation, which could result in a minor or moderate risk of injury to patient or operator and or damage to equipment or property.</p>
<p><b>ATTENTION!</b></p>	<p><b>(Without safety alert symbol)</b></p> <p>Indicates a situation that may result in damage to equipment or property.</p>
	<p><b>NOTE</b></p> <p><i>Useful additional information and tips.</i></p>

## Document Safety Symbols

Read and follow all safety instructions in the document and on the device.

	<p><b>WARNING!</b></p> <p>To reduce risk of injury, user(s) must carefully read and understand this document and be trained prior to use.</p>
	<p><b>WARNING!</b></p> <p>The system must be assembled and installed by TIDI Products authorized representatives.</p>
	<p><b>WARNING! COLLISION RISK</b></p> <p>Leaving Lock Pin in disengaged (unlocked ) position, while operating Boom Arm, may lead to collisions with other devices in operating room.</p>
	<p><b>Warning: Magnetic Field Hazard</b></p> <p><b>CARDIAC DEVICE RISK</b></p> <p>Zero-Gravity body shield connects magnetically to the vest and may cause a hazard with user defibrillators or pacemakers.</p>
	<p><b>WARNING! RADIATION HAZARD</b></p> <p>Using a radiation source above the user, or directly in front (in the path of the Image Intensifier) of the user is NOT permitted.</p>
	<p><b>WARNING! INJURY RISK-CABLE HAZARD</b></p> <p>Annual inspections must be performed on the cable. Cables must be replaced if there are signs of wear.</p>
	<p><b>WARNING! INJURY RISK-CABLE HAZARD</b></p> <p>Excessive rotation of Body Shield may cause Balancer Cable to break. The Body Shield must be lowered and allowed to unwind after each use, in an unlocked position. Annual inspections must be performed on the cable. Cables must be replaced if there are signs of wear.</p>
	<p><b>WARNING! TIP OVER HAZARD</b></p> <p>Lower assembly to lowest height prior to transport.</p>
	<p><b>WARNING! TIP OVER HAZARD</b></p> <p>To relocate device in surgical suite: raise leveling feet; roll over flat surfaces with no obstructions.</p>







	<p><b>WARNING! TRIP HAZARD</b></p> <p>After the system is relocated, reassembly includes leveling the Base according to Level the Base in this document. The Leveling Feet will be on the ground and the Leveling Foot Posts will be below the top surface of the Base.</p>
	<p><b>WARNING! RADIATION HAZARD</b></p> <p>The Body Shield must be handled with care to avoid damage to the Body Shield protective lead material. If the Body Shield is damaged, it must be inspected according to the Body Shield and Face Shield Fluoroscopy Inspection section of the User's Guide (TIDI Products document 84000).</p>
	<p><b>WARNING! INJURY RISK-BALANCER</b></p> <p>Balancer installation, service, and maintenance must be carried out by qualified personnel. These personnel should be alerted to the dangers associated with spring balancers. Spring balancers contain a spring under extreme force and can cause severe injury.</p>
	<p>Should the Body or Face Shield display any breaks or tears, replace the damaged item(s) immediately. The Body Shield, Shoulder Shields, and Face Shield contain lead and must be disposed of according to the Disposal section of this document.</p>
	<p><b>WARNING! RADIATION HAZARD</b></p> <p>Stand clear of Fluoro beam path, keep hands and arms out of beam path.</p>
	<p>Use caution when handling lead apron, make sure not to crease or fold any part, as it may result in damage to the lead shielding.</p>
	<p><b>WARNING!</b></p> <p>All replacement parts must be installed by a TIDI Products representative or a representative approved by TIDI Products.</p>
	<p><b>WARNING! INJURY RISK-BALANCER CABLE</b></p> <p>Unlocking balancer lock screw without body shield attached can cause severe injury. If the body shield is not attached, the Zero-Gravity balancer cable may rapidly retract in an uncontrolled manner.</p>
	<p><b>CAUTION! INJURY RISK</b></p> <p>Failure to maintain control of column, when raising or lowering, can result in personal injury or property damage.</p>
	<p><b>CAUTION! INJURY RISK</b></p> <p>Do not attempt to relocate Floor Unit during a procedure. Incorrect system positioning or adjustment may cause personal injury or equipment damage.</p>

## Zero-Gravity® Radiation Protection System User's Guide

	<p><b>CAUTION! INJURY RISK</b></p> <p>Ensure all Leveling Feet contact the floor.</p>
	<p><b>CAUTION! EQUIPMENT DAMAGE RISK</b></p> <p>The 66-inch-long Boom has stop screws to limit positioning. Travel is limited to avoid unsafe loading on the Boom. Do not remove the travel limiting screws (ZGCM-66 only).</p>
	<p><b>WARNING! Pinch Point</b></p> <p>Always keep hands and body clear of device during operation. Failure to keep hands and body clear could result in serious injury.</p>
	<p><b>CAUTION! PINCH POINT HAZARD</b></p> <p>Use care when sliding the Boom under the Swivel Center. Fingers or hands can be pinched between the Swivel and stop screws in the top of the Boom or between the Swivel and End Stop Cap.</p>
	<p><b>WARNING! PINCH POINT</b></p> <p>Use Caution when closing the tab on the adjustable handle.</p>
	<p><b>CAUTION! PINCH POINT HAZARD</b></p> <p>Never push or pull Zero-Gravity base by placing hands on large D-shape plate. Casters may swivel and pinch hands or fingers. Always use lift handles to move Zero-Gravity system.</p>
	<p><b>WARNING! RADIATION EXPOSURE</b></p> <p>Failure to set Body Shield at the proper height, failure to use a Vest, failure to couple Vest to Body Shield, or failure to lower Shoulder Shields into position may cause excess body, cranium or lens radiation exposure. DO NOT expose unprotected back to radiation source!</p>
	<p><b>WARNING! HANDLING PEOPLE HAZARD</b></p> <p>Handling people with this equipment can cause severe injury. Do not use for lifting, lowering, or transporting people.</p>
<b>ATTENTION!</b>	<p><b>A USER GUIDE FINAL ACCEPTANCE</b> checklist is required as proof of system operational validation prior to clinical use.</p>
<b>GENERAL</b>	<p>Personnel working with Zero-Gravity system(s) must be properly trained. Repairs or maintenance may only be performed by TIDI Products representative or representatives authorized by TIDI Products.</p>

## Device Safety Symbols

Important information on the device is marked with symbols and keywords.

	<p><b>WARNING! TIP OVER HAZARD</b></p> <p>Do not lean or hang on boom.</p>
	<p><b>WARNING!</b></p> <p><b>MAGNETIC FIELD HAZARD:</b> <b>CARDIAC DEVICE RISK</b></p> <p>The Zero-Gravity body shield is magnetically coupled to the Zero- Gravity vest and may cause a hazard with user defibrillators or pacemakers.</p>
	<p><b>WARNING!</b></p> <p><b>RADIATION EXPOSURE</b></p> <p>Failure to set body shield at the proper height, failure to use a vest, failure to couple vest to body shield, or failure to lower shoulder shields into position may cause excess body cranium or lens radiation exposure. NEVER expose unprotected back to radiation source!</p>
	<p><b>CAUTION! PINCH POINT</b></p> <p>Always keep hands and feet clear of device during operation. Failure to keep hands and feet clear could result in serious injury.</p>
	<p><b>ATTENTION! TRIP HAZARD</b></p> <p>Low light reflective tape strips located on base help users see and avoid a trip hazard.</p>
	<p><b>WARNING! COLLISION RISK</b></p> <p>Collision can cause damage to equipment or personnel. If collision occurs, immediately have Zero- Gravity inspected by a qualified service technician.</p>
	<p><b>CAUTION! EQUIPMENT DAMAGE</b></p> <p>Do not remove Rail End Stops, allowing the Carriages to accidentally slide off the Rail. Ball bearings may be lost if the Carriages are removed.</p>



**CAUTION! COLLISION RISK**

Retract Handle to highest position when not in use to avoid damage to equipment and personnel.



**READ INSTRUCTIONS FOR USE**

To reduce risk of injury, user(s) must carefully read and understand this document and be trained prior to use.



**CAUTION! RADIATION RISK**

To reduce risk of injury, user(s) must exercise caution to avoid contamination with or undue exposure to ionizing radiation.



## Device Operation Symbols

Important information on the device is marked with symbols and keywords. (Additional Body Shield and Vest Labels can be found in the Index in the back of this manual.)

	<p>Locking Pin is used in adjusting vertical column height. If Pin is disengaged vertical column height is adjustable. If Pin is engaged vertical column height is fixed.</p>
	<p>Vertical Column Snubber Handle is used in adjusting vertical column height in conjunction with the locking pin. Vertical column height is fixed when Handle is locked. Vertical column height is adjustable when Handle is unlocked.</p>
	<p>Bearing Rotational Lock is used to stop the boom arm from swinging. If the Boom Lock is fastened, the Boom Arm is fixed to the vertical column. If the Boom Lock is unfastened, the boom is free to rotate.</p>
	<p>Caster Wheel Lock is used to fix the position of the base on the floor. If the casters are locked, they will not roll or swivel. If the casters are unlocked, they will roll and swivel.</p>
	<p>Leveling Feet are used to level the unit for use and help fix it to one location on the floor. Lower the leveling feet to the ground to fix the unit to one location on the floor. Raise the leveling feet to move the unit. Fine adjustments to level the base are also made using the leveling feet.</p>
	<p>Boom Arm Adjustment Knob allows Boom adjustment relative to the Swivel Center. If locked the Boom length cannot be adjusted. If unlocked, the Boom length can be adjusted.</p>
	<p>The Pull Pin Handle allows rotational Boom adjustment. If locked, the Boom will not rotate. If unlocked, the Boom will rotate.</p>

# Zero-Gravity® Radiation Protection System User's Guide



Handle label shows how to operate the adjustable length feature of the handle.

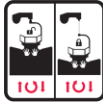

“Overhead Twist and Lock” is used during storage. If locked, the Body Shield is in a fixed position. If unlocked, the Body Shield is free to move.



**BODY SHIELD:** H; Pb 1.00 (FRONT);  
Pb 0.50 (SIDE) / 150 kVp\*; MM\*

**FACE SHIELD:** Pb 0.50/150 kVp\*

Zero-Gravity Body and Face Shield, P/N ZGBFS  
\*IEC 61331-3:2014 (NARROW BEAM CONDITIONS)

S/N 123456

TIDI Products, LLC  
570 Enterprise Drive  
Neenah, WI 54956 USA  
P. 1.800.521.1314  
P. 1.920.751.4300  
www.tidiproducts.com



  
<https://www.tidiproducts.com/fu>



ANNEX II,  
PPE REGULATION  
(EU) 2016/425  
271U00120 REV 00  
ZGBFS-310-000

Body Shield System Label is used to define the Body Shield:

- H designates a heavy protective apron per IEC 61331-3:2014, Section 5.2
- MM designates an apron sized per IEC 61331-3:2014, Section 5.2 with
  - A=50.0 inches (127.0 centimeters)
  - B=23.6 inches (60.0 centimeters)
  - C=37.4 inches (95.0 centimeters)
- Front (1.0), side (0.5), and Face Shield (0.5) radiation protection in millimeters of lead equivalent per 150 kVp (Narrow Beam Conditions)
- Standards followed
- Contact information



Shield height label is used to set magnet to proper Body Shield height to connect with Vest.



+/- Balancer label shows tightening and loosening directions for adjusting Balancer.



Column height label is used to set preferred boom height.

## Body Shield Overview



See **Figure 1** below and the chart on the next page for dimensions to define the protection area for body shield users.

Figure 1

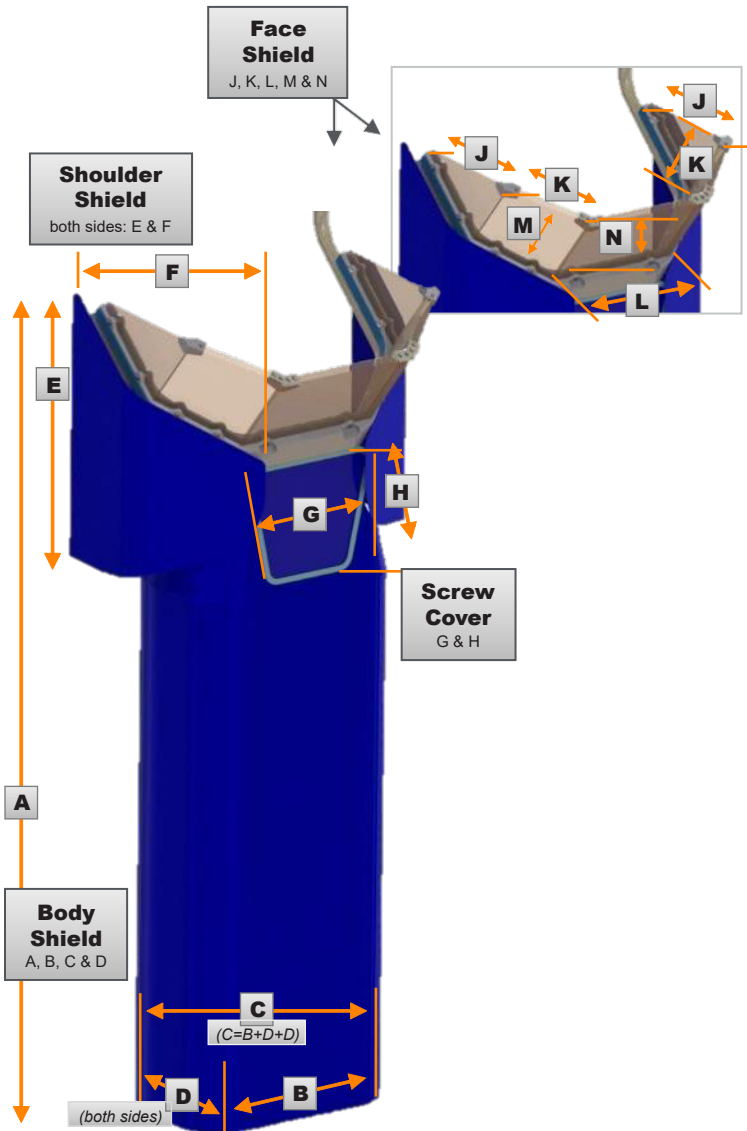

## Figure 1 Chart

\* IEC 61331-3-Section 5.3, a standard that defines sizing for wrap around radiation aprons is not applicable to the Body Shield. Zero-Gravity meets or exceeds the cited requirements. See Figure 1 and the chart below.

Dimension	Item	Inch	Centimeter	Lead Thickness Equivalent (millimeters)**	IEC 61331-3 Section 5.3 Size
A*	Body Shield	50.0	127.0	1.0 or 0.5/150 Peak kilovoltage	MM
B*	Body Shield	23.6	60.0	1.0/150 Peak kilovoltage	Medium B
C*	Body Shield	37.4	95.0	1.0 or 0.5/150 Peak kilovoltage	N/A
D	Body Shield	6.9	17.5	0.5/150 Peak kilovoltage	N/A
E (Both Sides)	Shoulder Shield	17.7	45.0	1.0/150 Peak kilovoltage	N/A
F (Both Sides)	Shoulder Shield	15.0	38.0	1.0/150 Peak kilovoltage	N/A
G	Screw Cover	9.0	23.0	1.0/150 Peak kilovoltage	N/A
H	Screw Cover	7.9	20.0	1.0/150 Peak kilovoltage	N/A
J	Face Shield	7.0	18.0	0.5/150 Peak kilovoltage	N/A
K		6.3	16.0		
L		9.8	25.0		
M		6.3	16.0		
N		6.9	17.5		

## System Overview

Figure 2 (ZGM-6-5H)

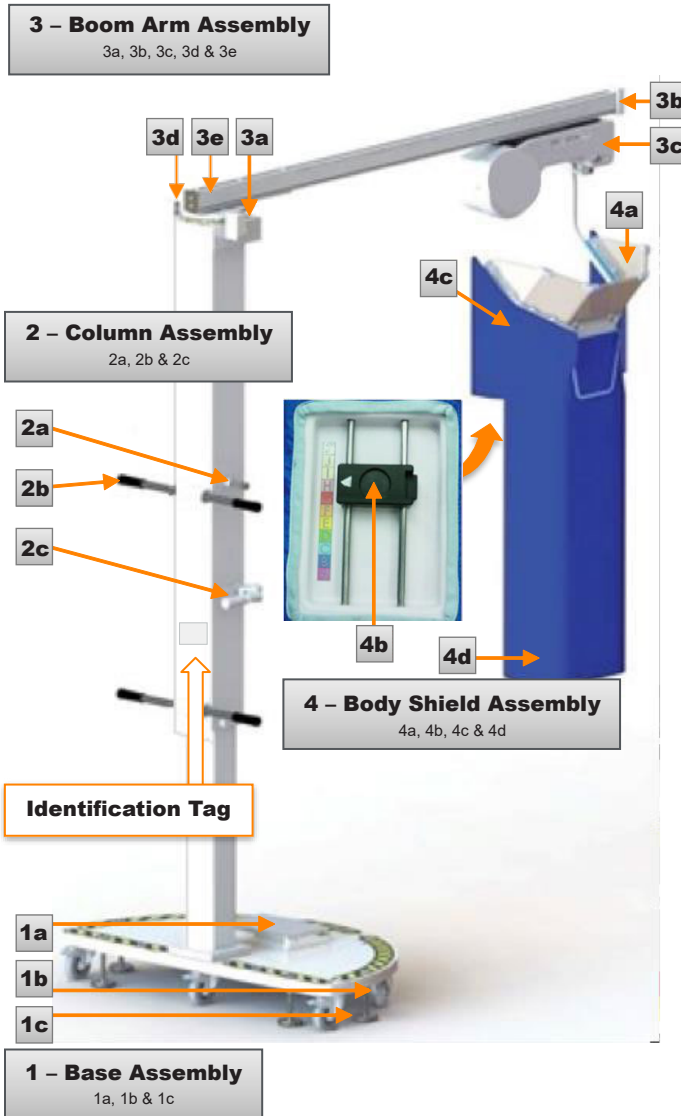

The Zero-Gravity Floor Unit has been designed to be placed in the operating room in a location that will provide access to the operating room table. Placement is determined primarily upon the clinical procedures performed at the facility.

Figure 2 Chart (ZGM-6-5H)

Item	Part	Purpose and Specification
1	Base Assembly	Supports column assembly (2) and boom arm assembly (3). Weight: 660 pounds (300 kilograms) Width: 48 inches (122 centimeters) Depth: 28 inches (71 centimeters)
1a	Toolbox	Contains: (1) each 5/16-inch, 5/32-inch and 1/8- inch hex wrenches; (1) flat blade screw driver; (1) 3/8-inch square drive ratchet wrench; (1) 3/8-inch square drive 17-millimeter-deep well socket; (1) 3/8-inch square drive 3/8-inch hex bit socket; (1) 3/8-inch square drive with 3-inch extension; (1) adjustable wrench, (1) Leveling Eye
1b	Locking Casters	If necessary, allows system to be repositioned within suite or moved to another suite.
1c	Leveling Feet	Used to stabilize and level system
2	Column Assembly	Telescoping, vertical column which locks into user-preferred heights (includes Identification Tag).
2a	Locking Pin	Spring loaded pull pin adjusts column assembly (2) height
2b	Lift Handles	Used to steer base (1) into position during relocation. Also used for raising column assembly (2) and boom arm assembly (3) into procedure position.
2c	Snubber Handle	Secures column assembly (2) into place in conjunction with the locking pin.
3	Boom Arm Assembly	Carries body shield (4d) and related parts. Length: 77 inches (196 centimeters)
3a	Turntable Bearing	Permits 150° rotation of boom arm assembly (3).
3b	End Stop Cap	Ensures balancer (3c) remains on boom arm assembly (3)
3c	Balancer	Supports body shield assembly (4)
3d	Bearing Rotational Lock	Used to stop the boom arm (3) from swinging.
3e	Docking Station	Using a magnet, prevents unwanted sliding of the Body Shield (4) when it is not in use

Figure 2 Chart (ZGM-6-5H)

Item	Part	Purpose and Specification
4	Body Shield Assembly (ZGBFS)	Consists of face shield (4a), Connector (4b), Right and Left shoulder flaps (4c), and body shield (4d). Total weight: ~ 54 pounds (24.5 kilograms)
4a	Face Shield	0.50-millimeter Pb Equivalent/150 Peak kilovoltage <sup>^</sup> . Eye shield UV scale Number 2-1.2/2C-1.2, Optical Class 1, Increased Robustness S.
4b	Connector	Secures body shield assembly (4) to user's vest, adjusts to 11 positions: 0.5 inch (1.3 centimeters) per position – 5 inches (13 centimeters) vertical range
4c	Shoulder Shields, Right (ZGSS-R) and Left (ZGSS-L)	1.00-millimeter Pb Equivalent/150 Peak kilovoltage <sup>^</sup>
4d	Body Shield	1.00-millimeter Pb Equivalent/150 Peak kilovoltage <sup>^</sup> on Front: .50-millimeter Pb Equivalent/150 Peak kilovoltage <sup>^</sup> on sides
Not shown	Vest	Worn by user to ensure proper alignment of body shield assembly (4), ensuring optimum protection of user. Sizes: Extra-Small (ZGAV-XS), Small (ZGAV-S), Medium (ZGAV-M), Large (ZGAV-L), Extra-Large (ZGAV-XL), Triple Extra-Large (ZGAV3XL)
Not shown	Sterile Cover (ZGD20WA- LOOP)	Polyethylene; used on body shield (4d) to maintain sterility.

Figure 2 – Other Considerations (ZGM-6-5H)

Other Considerations	Description
Base push force, starting resistance	Approximate Force: 31 pounds (138 Newtons)
Base push force, rolling resistance	Approximate Force: 21 pounds (94 Newtons)
System height, maximum in use ("F" position)	108 inches (274 centimeters) when column (2) is fully extended
System height, minimum in use ("A" position)	94 inches (239 centimeters) when column (2) is retracted and boom arm assembly (3) attached
Transport height, minimum	78 inches (198 centimeters) when column (2) is fully retracted and boom arm assembly (3) is removed
Operational load, maximum (boom load)	70 pounds (32 kilograms)
User Stature	4 feet 10 inches (147 centimeters) to 6 feet 5 inches (196 centimeters)
Required Expertise	Educated in the use of radiology safety equipment, knowledge of and ability to maintain surgical sterility procedures, knowledge and understanding of risks involved in using radiology equipment, understands hygiene and sterility principles, experience in use of radiology equipment in a human operative environment.
Assembled weight	750 pounds (341 kilograms)

**Use Safety** Confirm that system has been installed per the TIDI Products issued *Installation Guide*.



**CAUTION! INJURY RISK**

Failure to maintain control of column, when raising or lowering, can result in personal injury or property damage.



**CAUTION! INJURY RISK**

Do not attempt to relocate Floor Unit during a procedure. Incorrect system positioning or adjustment may cause personal injury or equipment damage.



Figure 3 (ZGHSA)

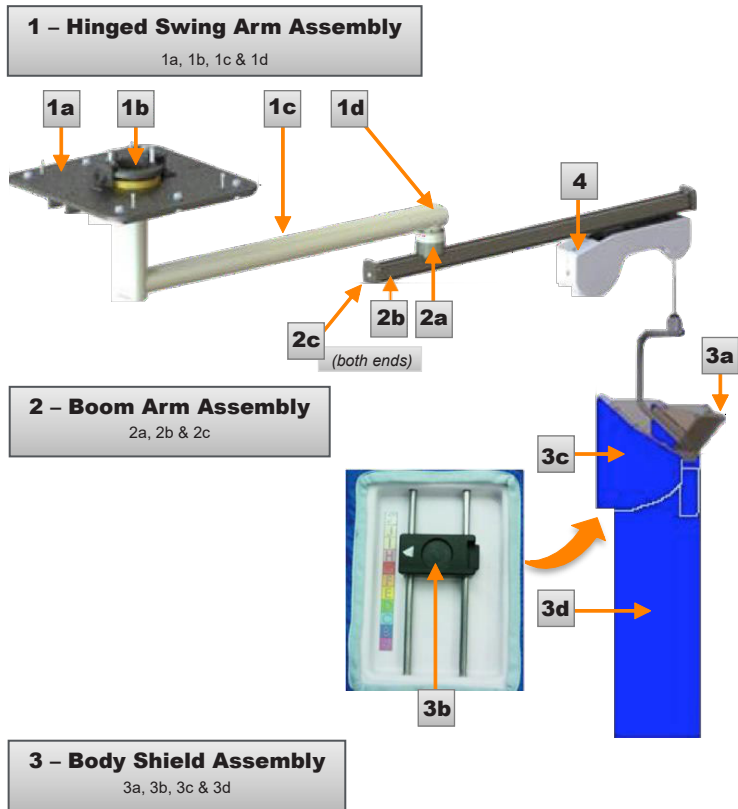

The Zero-Gravity Ceiling Mounted system has been placed in the operating room ceiling in a location that will provide access to the operating room table. Placement is determined primarily upon the clinical procedures performed at the facility.

The Zero-Gravity Hinged Swing Arm (ZGCM-HSA) system will be installed to access one side of the table, or both sides of the table.

Figure 3 Chart (ZGHSA)

Item	Part	Purpose and Specification
1	Hinged Swing Arm Assembly	Supports the boom arm assembly (2). Total weight: ~ 340 pounds (154 kilograms)
1a	Support Plate Assembly	Provides rigid support and fastens unit to the ceiling. Total weight: ~ 200 pounds (90 kilograms)
1b	Ceiling Swivel	Allows unit to rotate 360 degrees around procedure room
1c	Drop Tube	Connects the Boom Arm Assembly (2) to ceiling swivel (1b) Total weight: ~ 140 pounds (64 kilograms)
1d	Identification Tag	Provides identifying information for the unit.
2	Boom Arm Assembly	Carries body shield and related parts. Boom Arm is 65 inches (165 centimeters) long with a total weight of 40 pounds (18 kilograms)
2a	Swivel Support	Mounted to Drop Tube (1c), supports Boom Arm Assembly (2)
2b	Docking Station	Using a magnet, prevents unwanted sliding of the Body Shield (3) when it is not in use
2c	End Stop Cap	Ensures balancer (4) remains on boom arm assembly (2).
3	Body Shield Assembly (ZGBFS)	Consists of Face Shield (3a), Connector (3b), and Body Shield (3d). Total weight ~ 54 pounds (24.5 kilograms).
3a	Face shield	0.50-millimeter Pb Equivalent / 150 kVp <sup>^</sup> . Eye shield UV scale Number 2-1.2/2C-1.2, Optical Class 1, Increased Robustness S.
3b	Connector	Secures Body Shield Assembly (3) to user Vest, adjusts to 11 positions: 0.5 inch (1.3 centimeters) per position – 5 inches (13 centimeters) vertical range
3c	Shoulder Shields, Right (ZGSS-R) and Left (ZGSS-L)	1.00-millimeter Pb / 150 kVp <sup>^</sup>
3d	Body shield	1.00-millimeter Pb / 150 kVp <sup>^</sup> on front 0.50-millimeter Pb Equivalent / 150 kVp <sup>^</sup> on sides
4	Balancer	Supports leaded Body Shield Assembly (3).

<sup>^</sup>Narrow Beam Conditions

Figure 3 Chart (ZGHSA)

Item	Part	Purpose and Specification
Not shown	User Tool Kit	<ul style="list-style-type: none"> <li>• 17-millimeter-deep well socket, 3/8-inch square drive</li> <li>• 3-inch extension with 3/8-inch square drive</li> <li>• 5/32-inch ball end hex key wrench</li> <li>• 7 1/2-inch ratchet (3/8-inch drive)</li> </ul>
Not shown	Vest	Worn by user to ensure proper alignment of Body Shield assembly (3), ensuring optimum protection of user. Sizes: Extra-Small (ZGAV-XS), Small (ZGAV-S), Medium (ZGAV-M), Large (ZGAV-L), Extra-Large (ZGAV-XL), Triple Extra-Large (ZGAV-3XL)
Not shown	Sterile cover (ZGD20WA-LOOP)	Polyethylene; used on body shield to maintain sterility.

Figure 3 – Other Considerations (ZGHSA)

Other Considerations	Description
Required Ceiling Height	107 inches (272 centimeters) minimum
Balancer Working Length	46.5 inches (118 centimeters)
Assembled Weight	~ 500 pounds (227 kilograms)
Boom Arm Rotation	360°
Drop Tube Rotation	360°; or angle limiting with cushioned stops
Operational load, maximum (boom load)	~ 74 pounds (34 kilograms)
User Stature	4 feet 10 inches (147 centimeters) to 6 feet 5 inches (196 centimeters)
Required Expertise	Educated in the use of radiology safety equipment, knowledge of and ability to maintain surgical sterility procedures, knowledge and understanding of risks involved in using radiology equipment, understands hygiene and sterility principles, experience in use of radiology equipment in a human operative environment.

Figure 4 (ZGCM-48 | ZGCM-66)

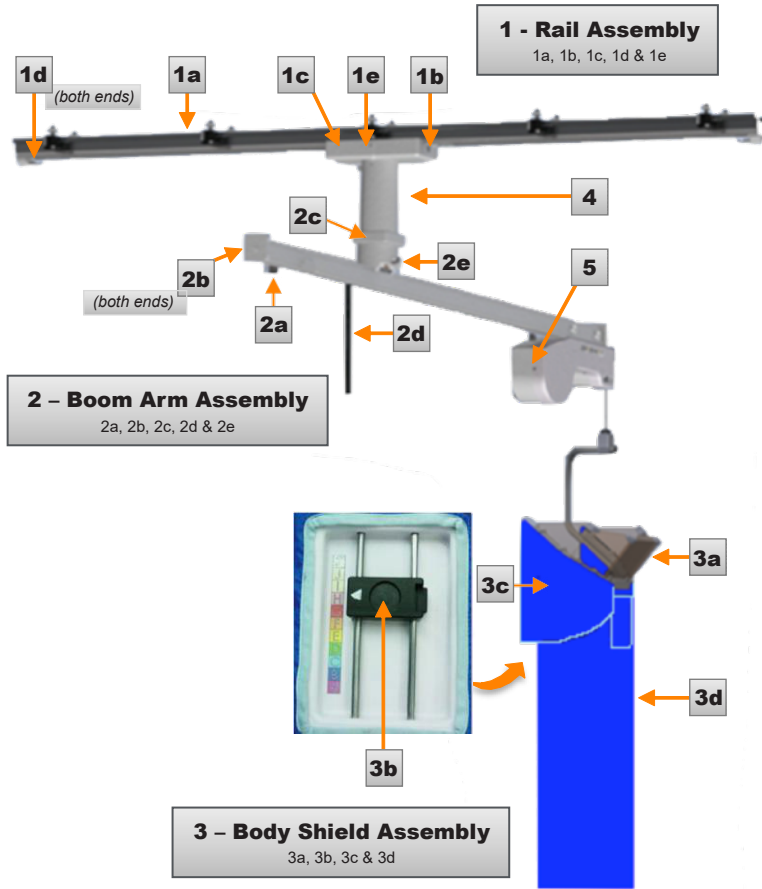

The Zero-Gravity Ceiling Mounted system has been placed in the operating room ceiling in a location that will provide access to the operating room table. Placement is determined primarily upon the clinical procedures performed at the facility.

There are two different sizes of Zero-Gravity Monorail systems. The systems are identical except for the length of the Boom Arm assembly.

- 48-inch (122 centimeter) model (ZGCM-48) provides access to one side of the table
- 66-inch (168 centimeter) model (ZGCM-66) provides access to both sides of the table

Figure 4 Chart (ZGCM-48 | ZGCM-66)

Item	Part	Purpose and Specification
1	Rail Assembly	Supports the Drop Tube (4). Total weight: 150 pounds (68.0 kilograms)
1a	Rail	Ceiling mounted, supports Carriage, <b>Width:</b> 5 inches (12.7 centimeters) <b>Length:</b> 118 inches (3 meters).
1b	Carriage	Provides mounting surface for Drop Tube (4) and travels up and down the Rail (1a).
1c	Carriage Covers	Protect Carriage (1b).
1d	End Stop	Provides a positive stop for the Carriage (1b).
1e	Identification Tag	Provides identifying information for the unit.
2	Boom Arm Assembly	Carries Body Shield and related parts <ul style="list-style-type: none"> <li>• ZGCM-48 is 65 inches (165 centimeters) long with a total weight: 40 pounds (18 kilograms).</li> <li>• ZGCM-66 is 107 inches (272 centimeters) long with a total weight of 50 pounds (23 kilograms).</li> </ul>
2a	Docking Station	Using a magnet, prevents unwanted sliding of the Body Shield (3) when it is not in use
2b	End Stop Cap	Ensures Balancer (5) remains on Boom Arm assembly (2).
2c	Swivel Assembly	Permits 360° rotation of boom arm assembly (2).
2d	Lock Pin	Allows the Boom Arm assembly (2) to lock to one of (6) preset positions. Actuation is with a pull pin handle.
2e	Boom Arm Adjustment Knob	Clamps and unclamps to allow the Boom Arm to adjust the length of the Boom under the Swivel Center.
3	Body Shield Assembly (ZGBFS)	Consists of Face Shield (3a), Body Shield (3d), and Connector (3b). Total weight ~ 54 pounds (24.5 kilograms).
3a	Face shield	0.50-millimeter Pb Equivalent / 150 kVp <sup>^</sup> . Eye shield UV scale Number 2-1.2/2C-1.2, Optical Class 1, Increased Robustness S.
3b	Connector	Secures Body Shield assembly (3) to user Vest, adjusts to 11 positions: 0.5 inch (1.3 centimeters) per position – 5 inches (13 centimeters) vertical range
3c	Shoulder shields Right (ZGSS-R) and Left (ZGSS-L)	1.00-millimeter Pb / 150 kVp <sup>^</sup>
3d	Body Shield	1.00-millimeter Pb / 150 kVp <sup>^</sup> on front 0.50-millimeter Pb Equivalent / 150 kVp <sup>^</sup> on sides
4	Drop Tube	Mounted to the Carriage (1b), supports Boom Arm assembly (2).
5	Balancer	Supports leaded Body Shield assembly (3).

<sup>^</sup>Narrow Beam Conditions

Figure 4 Chart (ZGCM-48 | ZGCM-66)

Item	Part	Purpose and Specification
Not Shown	User Tool Kit	<ul style="list-style-type: none"> <li>• 17-millimeter-deep well socket, 12 point with 3/8-inch square drive</li> <li>• 3-inch extension with 3/8-inch square drive</li> <li>• 1/8-inch ball end hex key wrench</li> <li>• 5/32-inch ball end hex key wrench</li> <li>• 3/16-inch standard blade screwdriver with 6 3/4-inch overall length</li> <li>• 7 1/2-inch ratchet with speed ring (3/8-inch drive)</li> <li>• 6-inch adjustable wrench-with 15/16-inch capacity</li> </ul>
Not shown	Vest	<p>Worn by user to ensure proper alignment of Body Shield assembly (3), ensuring optimum protection of user. Sizes:</p> <p>Extra-Small (ZGAV-XS),                      Small (ZGAV-S),                      Medium (ZGAV-M),                      Large (ZGAV-L),                      Extra-Large (ZGAV-XL),                      Triple Extra-Large (ZGAV-3XL)</p>
Not shown	Sterile cover (ZGD20WA-LOOP)	Polyethylene; used on Body Shield (3) to maintain sterility.

Figure 4 – Other Considerations (ZGCM-48 | ZGCM-66)

Other Considerations	Description
Required Ceiling Height	102 inches (259 centimeters) minimum
Balancer Working Length for ZGCM-48	46.5 inches (118 centimeters)
Balancer Working Length for ZGCM-66	89.0 inches (226 centimeters)
Carriage Working Length (between End Stops)	96.0 inches (244 centimeters)
Assembled weight ZGCM-48	~ 315 pounds (143 kilograms)
Assembled weight ZGCM-66	~ 325 pounds (147 kilograms)
Boom Arm Rotation	360°; or angle limiting with lock pin option in 6 positions.
Operational load, maximum (boom load)	~ 74 pounds (34 kilograms)
User Stature	4 feet 10 inches (147 centimeters) to 6 feet 5 inches (196 centimeters)
Required Expertise	Educated in the use of radiology safety equipment, knowledge of and ability to maintain surgical sterility procedures, knowledge and understanding of risks involved in using radiology equipment, understands hygiene and sterility principles, experience in use of radiology equipment in a human operative environment.

Figure 5 (ZGCM-HSA)

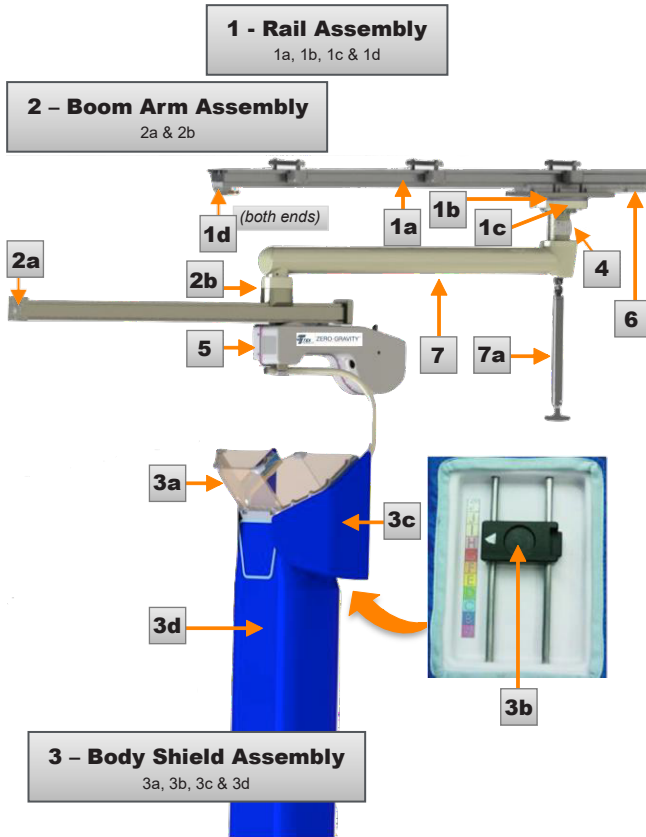

The Zero-Gravity Ceiling Mounted system has been placed in the operating room ceiling in a location that will provide access to the operating room table. Placement is determined primarily upon the clinical procedures performed at the facility.

The Zero-Gravity Monorail Hinged Swing Arm (ZGCM-HSA) system has been developed to provide 360° positioning of the hanging body and head shield for a variety of procedures. Zero-Gravity glides out of the way and can be stowed to the side.



Figure 5 Chart (ZGCM-HSA)

Item	Part	Purpose and Specification
1	Rail Assembly	Supports the Drop Tube (4). Total weight: 150 pounds (68.0 kilograms)
1a	Rail	Ceiling mounted, supports Carriage, Width: 5 inches (12.7 centimeters) Length: 118 inches (3 meters).
1b	Carriage	Provides mounting surface for Drop Tube (4) and travels up and down the Rail (1a).
1c	Carriage Covers	Protect Carriage (1b).
1d	End Stop	Provides a positive stop for the Carriage (1b).
2	Boom Arm Assembly	Carries Body Shield and related parts. Length: 59 inches (150 centimeters). Total weight ~ 40 pounds (18 kilograms).
2a	End Stop Cap	Ensures Balancer (5) remains on Boom assembly (2).
2b	Swivel Support	Mounted to Swivel Boom Assembly (7), permits 360° rotation of Boom Arm Assembly (2).
3	Body Shield Assembly (ZGBFS)	Consists of Face Shield (3a), Body Shield (3d), and Connector (3b). Total weight ~ 54 pounds (24.5 kilograms).
3a	Face shield	0.50-millimeter Pb Equivalent / 150 kVp <sup>^</sup> . Eye shield UV scale Number 2-1.2/2C-1.2, Optical Class 1, Increased Robustness S.
3b	Connector	Secures Body Shield assembly (3) to user Vest, adjusts to 11 positions: 0.5 inch (1.3 centimeters) per position – 5 inches (13 centimeters) vertical range
3c	Shoulder shields, Right (ZGSS-R) and Left (ZGSS-L)	1.00-millimeter Pb / 150 kVp <sup>^</sup>
3d	Body Shield	1.00-millimeter Pb / 150 kVp <sup>^</sup> on front 0.50-millimeter Pb Equivalent / 150 kVp <sup>^</sup> on sides
4	Drop Tube	Mounted to the Carriages (1b), supports Swivel Assembly (7).
5	Balancer	Supports leaded Body Shield assembly (3).
6	Identification Tag	Provides identifying information for the unit.
7	Swivel Boom Assembly	Mounted to Drop Tube (4). Provides a double swivel connection to support Boom Arm Assembly (2).
7a	Handle	Used to push or pull carriage (1b) on the Rail Assembly (1).

<sup>^</sup>Narrow Beam Conditions

Figure 5 Chart (ZGCM-HSA)

Item	Part	Purpose and Specification
Not Shown	User Tool Kit	<ul style="list-style-type: none"> <li>• 17-millimeter-deep well socket, 12 point with 3/8-inch square drive</li> <li>• 3-inch extension with 3/8-inch square drive</li> <li>• 1/8-inch ball end hex key wrench</li> <li>• 5/32-inch ball end hex key wrench</li> <li>• 7 1/2-inch ratchet with speed ring (3/8-inch drive)</li> </ul>
See Figure 9	Vest	<p>Worn by user to ensure proper alignment of Body Shield assembly (3), ensuring optimum protection of user.</p> <p>Sizes:                      Extra-Small (ZGAV-XS),                      Small (ZGAV-S), Medium (ZGAV-M),                      Large (ZGAV-L),                      Extra-Large (ZGAV-XL),                      Triple Extra-Large (ZGAV-3XL)</p>
See Figure 3	Docking Station	Using a magnet, prevents unwanted sliding of the Body Shield (3) when it is not in use
Not shown	Sterile cover (ZGD20WA-LOOP)	Polyethylene; used on Body Shield (3) to maintain sterility.

Figure 5 – Other Considerations (ZGCM-HSA)

Other Considerations	Description
Required Ceiling Height	108 inches (274 centimeters) minimum
Balancer Working Length for ZGCM-HSA	46.5 inches (118 centimeters)
Carriage Working Length (between End Stops)	96.0 inches (244 centimeters)
Assembled weight ZGCM-HSA	~ 370 pounds (168 kilograms)
Boom Arm Rotation	360°
Operational load, maximum (boom load)	~ 74 pounds (34 kilograms)
User Stature	4 feet 10 inches (147 centimeters) to 6 feet 5 inches (196 centimeters)
Required Expertise	Educated in the use of radiology safety equipment, knowledge of and ability to maintain surgical sterility procedures, knowledge and understanding of risks involved in using radiology equipment, understands hygiene and sterility principles, experience in use of radiology equipment in a human operative environment.

## Using the System

---



### **WARNING!**

The system must be assembled and installed by TIDI Products authorized representatives.



### **WARNING! Pinch Point**

Always keep hands and body clear of device during operation. Failure to keep hands and body clear could result in serious injury.

## Position Zero-Gravity Floor Unit in the Procedure Room (ZGM-6-5H)



*Move the assembly to approximately 4 feet (1.2 meters) from the operative site, and clear of any ceiling and floor obstacles.*

Arm range of motion of body shield

- Zero-Gravity, when positioned between the surgical table and back table accommodates the length of a patient.
- Design allows body shield user to rotate 360° if necessary.
- Zero-Gravity adjusts for any vertical movement, including limited tilting and bending.

## Position Hinged Swing / Boom Arm Assembly (ZGHSA | ZGCM-48 | ZGCM-66 | ZGCM-HSA)

The Zero-Gravity Ceiling Mounted systems have adequate range of motion and rotation features in order to be flexible inside the operating room. An in-service visit from your TIDI Products approved representative is the best way to help determine the optimum set-up condition for the workflow of each room.

Room workflow decisions are needed to determine:

### **ZGHSA | ZGCM-HSA:**

- Location of the Docking Station to properly protect the sterile field
- Parking location when the system is not in use

### **ZGCM-48 | ZGCM-66:**

- Locked Swivel
- Unlocked Swivel
- Location of the Docking Station to properly protect the sterile field
- Parking location when the system is not in use

## Level the Base (ZGM-6-5H)



### CAUTION! INJURY RISK

Ensure all Leveling Feet contact the floor.

1. Lower the leveling feet with the 5/16-inch hex wrench until each foot contacts the floor (Figure 6).

Figure 6

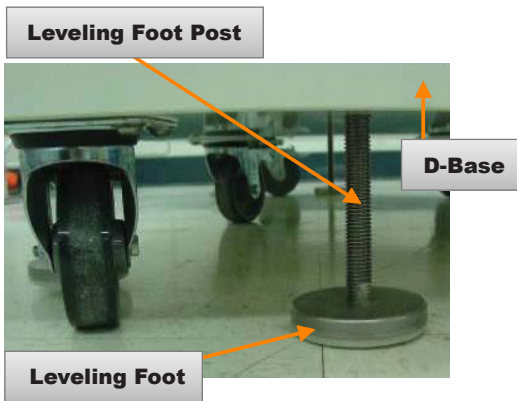

2. Complete the leveling process by centering the leveling bubble inside the toolbox on the top surface of the D-Base (Figure 7). Use the Leveling Feet to make fine adjustments.

Figure 7



When the base is level, the Leveling Foot Posts are below the top surface of the D-Base.

3. Press the tab down to lock the Casters and they will not roll or swivel (Figure 8).

*Figure 8*

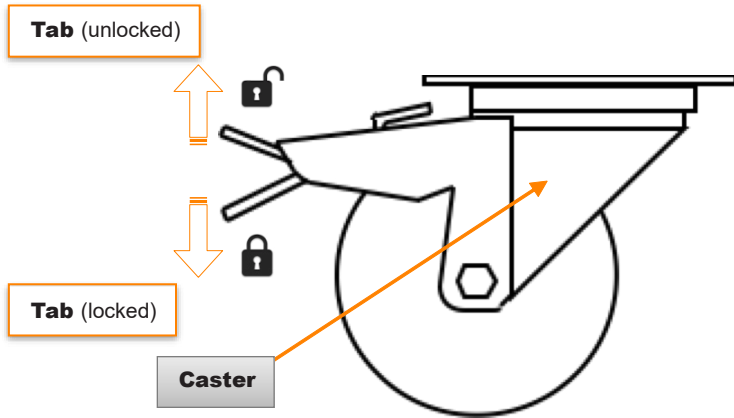

*Locking the casters prevents them from rolling and swiveling.*

## Set the Height (ZGM-6-5H)

Column height is adjusted in 3-inch (7.6 centimeter) increments over (6) positions as shown on the Column Height Label on the lower section of column assembly.



*Each user may have different height preferences, once heights are determined, you may want to make note of them for future room set-up.*

Figure 9

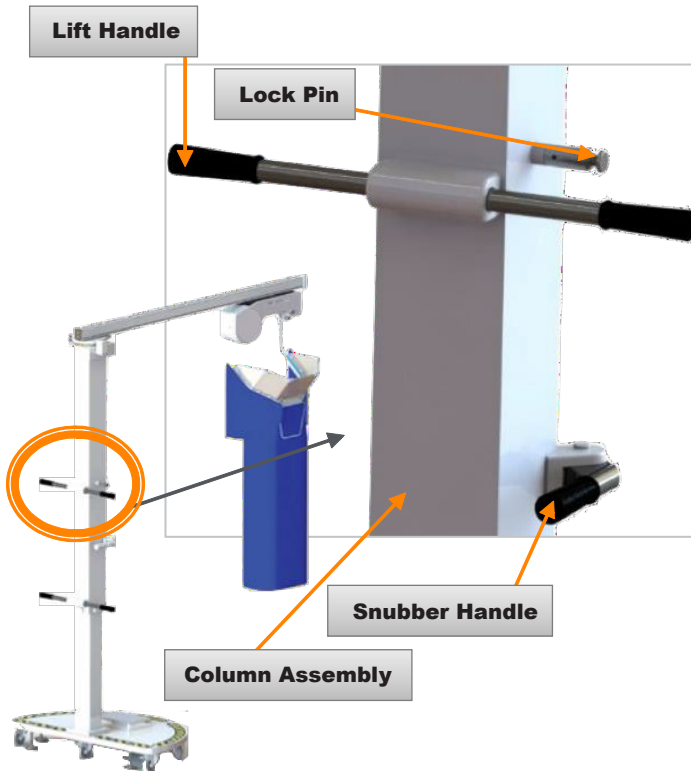

**TWO DEVICES MUST BE DISENGAGED TO POSITION THE VERTICAL COLUMN FOR ADJUSTMENT (FIGURE 9)**

- Lock Pin (Figure 10 and Figure 12)
- Snubber Handle (Figure 11 and Figure 13)

## TO UNLOCK THE VERTICAL COLUMN FOR ADJUSTMENT

- Disengage the lock pin (Figure 10) and unlock the snubber handle (Figure 11)
- The Lock Pin is disengaged when the pin is moved completely outside the slot (Figure 10):
  1. Push down lightly on the Lift Handles (Figure 9) and continue applying pressure while disengaging the Lock Pin (Figure 10).
  2. Pull the handle toward you until the pin meets resistance in the slot.
  3. Rotate the handle clockwise (to the right) until the pin meets resistance in the slot.
  4. Pull the handle towards you until the pin is clear of the slot.
  5. Rotate the handle counterclockwise (to the left) until the pin is out of the slot and rests against the pin body.

Figure 10

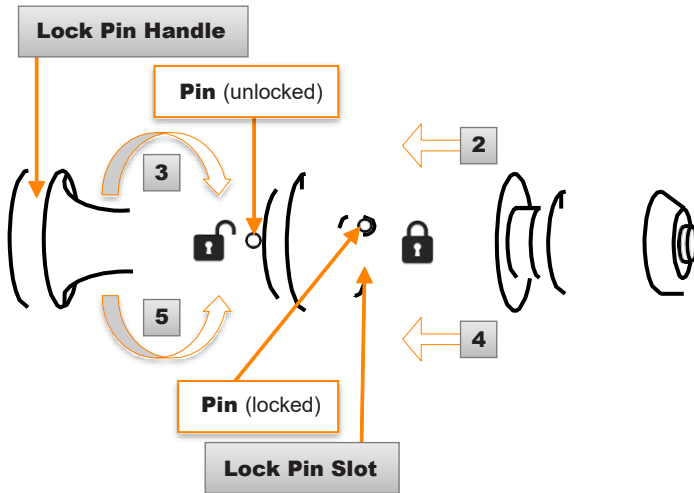



- The Snubber Handle is disengaged when it is pushed away from the vertical column (Figure 11).

Figure 11

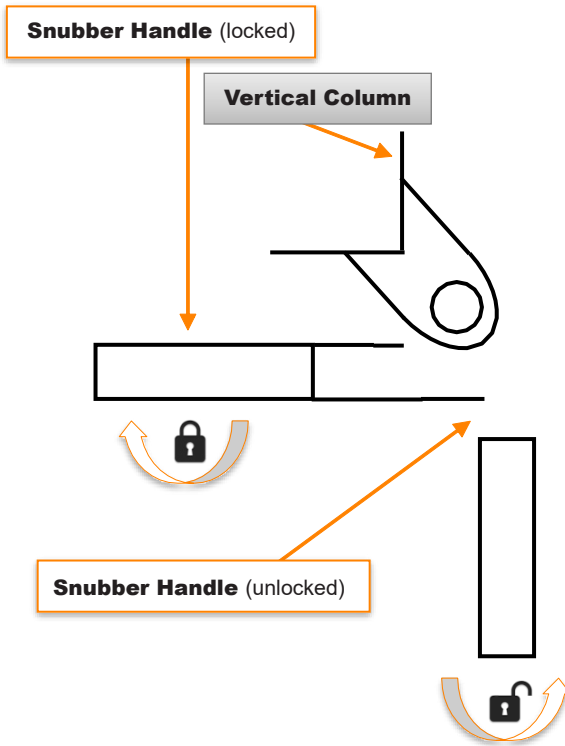

**You can now adjust the vertical column height by pushing or pulling on the Lift handles as needed.**

- Once the Vertical Column height is adjusted, the Lock Pin and Snubber Handle must be engaged (Figure 9)
- Engage the lock pin (Figure 12) and lock the Snubber handle (Figure 13).

Figure 12

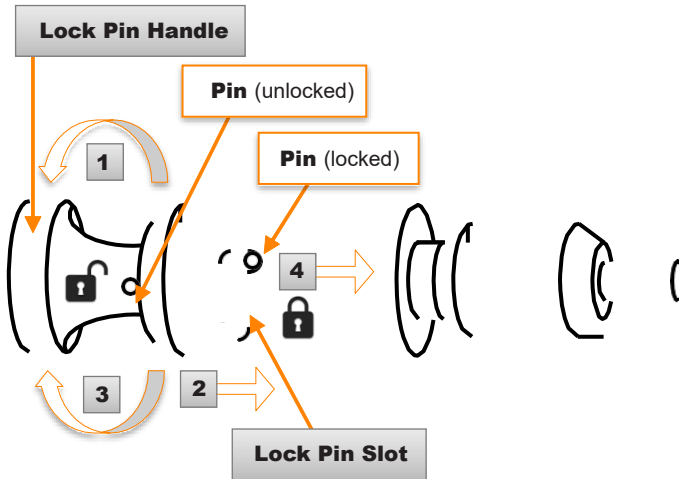

**THE LOCK PIN IS ENGAGED WHEN THE PIN IS MOVED COMPLETELY INSIDE THE SLOT (FIGURE 12)**

1. Rotate the handle clockwise (to the right) until the pin is trapped in the slot.
2. Allow the spring to push the pin into the column until the pin meets resistance in the slot.
3. Rotate the handle counterclockwise (to the left) until the pin meets resistance in the slot.
4. Allow the spring to push the pin fully into the column until the pin meets resistance in the slot.

- The Snubber Handle is engaged when it is pushed toward the vertical column (Figure 13)

Figure 13

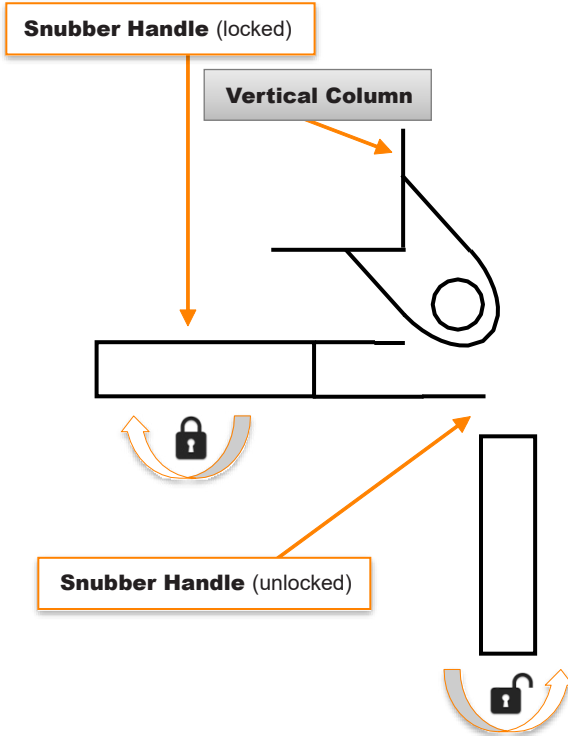

**The vertical column height is now locked.**

## Lock the Boom Arm (ZGM-6-5H)

A Latch near the top of the vertical column and a hook under the Boom Arm are provided to prevent Boom Arm rotation.

Figure 14

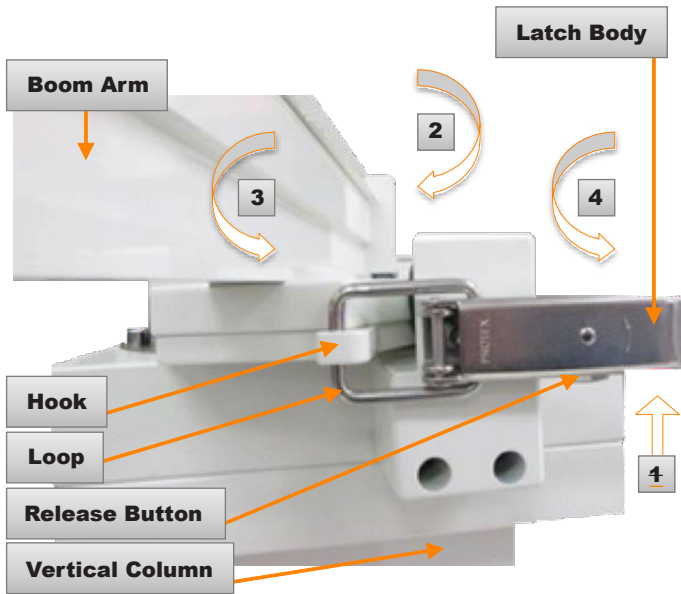

### TO LOCK THE BOOM ARM (FIGURE 14)

1. Press the release button on the bottom of the latch. This step is only necessary if the latch is in the locked position.
2. Rotate the body of the latch towards you to release it and position the loop.
3. Rotate the Boom Arm until it contacts the stop pad. Position the loop inside the hook.
4. Rotate the body of the latch away from you until it fastens. It should be parallel to the vertical column.

Figure 15

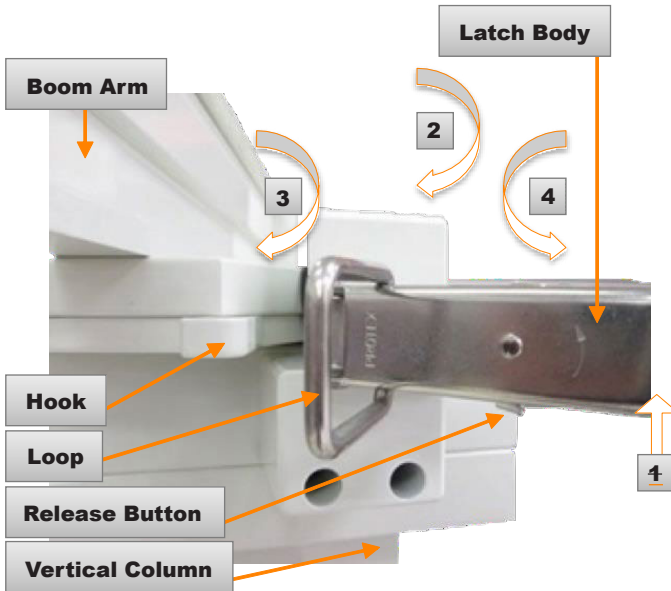

**TO UNLOCK THE BOOM ARM (FIGURE 15)**

1. Press the release button on the bottom of the latch.
2. Rotate the body of the latch towards you to release it and move the loop away from the hook.
3. Rotate the Boom Arm until the hook is free of the loop.
4. Rotate the body of the latch away from you until it fastens. It should be parallel to the vertical column.

## Adjust Boom Arm Angle (ZGCM-48 | ZGCM-66)

The Zero-Gravity Boom is designed to swivel, providing adequate range of motion inside the operating theater. There are two modes of operation for this swivel feature:

- An unlocked swivel provides the largest range of motion when there is no threat of overhead collisions in the work zone.
- A locked swivel provides a safe zone to access patients when there is a threat of overhead collisions.



### WARNING! COLLISION RISK

Leaving Lock Pin in disengaged (unlocked ) position, while operating Boom Arm, may lead to collisions with other devices in operating room.



### CAUTION! EQUIPMENT DAMAGE RISK

The 66-inch-long Boom has stop screws to limit positioning. Travel is limited to avoid unsafe loading on the Boom. Do not remove the travel limiting screws (ZGCM-66 only).

Figure 16

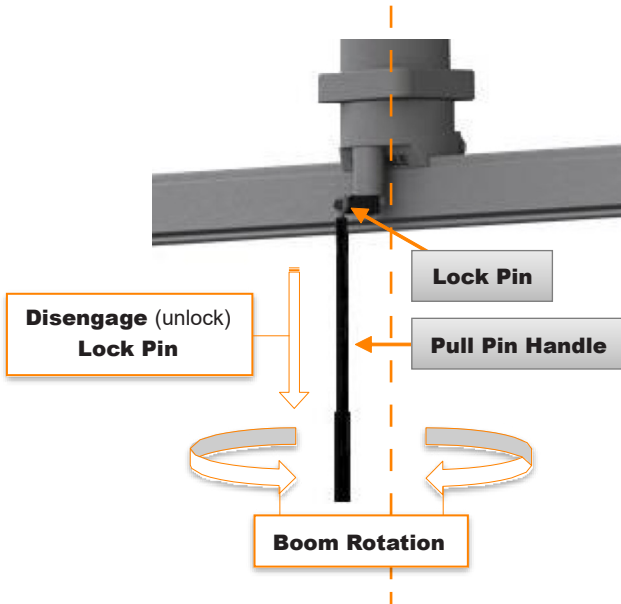
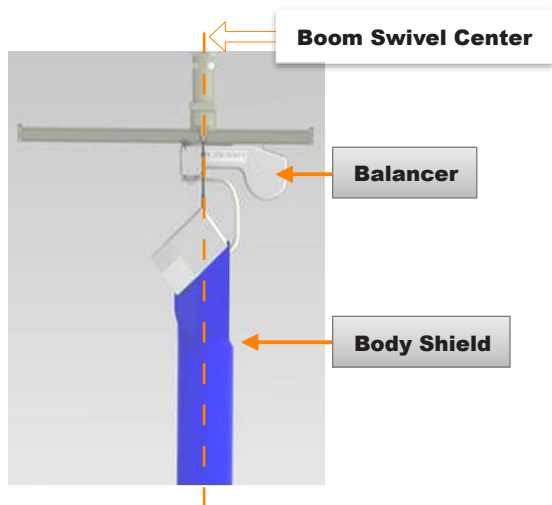

Figure 17



1. Slide Balancer and Body Shield directly under Swivel Center (Figure 17).
2. Pull the Pull Pin Handle down to disengage (unlock) Lock Pin and rotate handle 45° to lockout position. Release Pull Pin Handle. Boom will now rotate freely (Figure 16).
3. Place Boom Arm at desired angle (Figure 18). Pull down Pull Pin Handle again and rotate back to the center to lock Boom Swivel. Release Pull Pin Handle. Lock pin will reseat. Gently move Boom Arm back and forth to ensure that Boom Swivel is locked again (Figure 16).



*Users less than 5 feet-6 inches (168 centimeters) tall, may require a step stool to access Pull Pin Handle.*



**CAUTION! PINCH POINT HAZARD**

Use care when sliding the Boom under the Swivel Center. Fingers or hands can be pinched between the Swivel and stop screws in the top of the Boom or between the Swivel and End Stop Cap.

Figure 18



*It is not possible to lock Boom in a position parallel to Rail Assembly.*

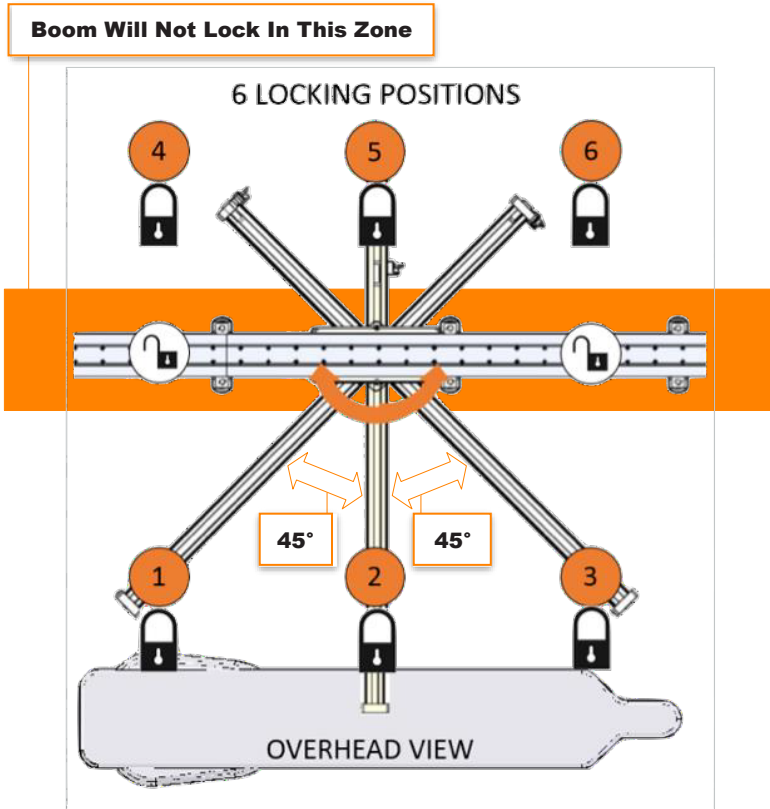



## Maneuver the Boom Arm Assembly (ZGCM-HSA)

Use the adjustable length Handle to maneuver the Swivel Boom Assembly on the Rail Assembly into position (Figure 19).

Figure 19

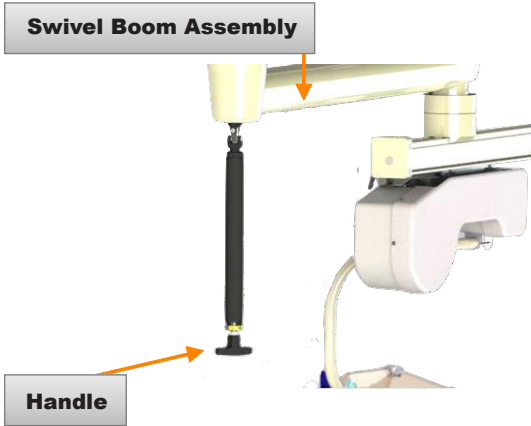

### CAUTION! Pinch Point

Use caution when closing the tab on the Adjustable Handle.

Figure 20

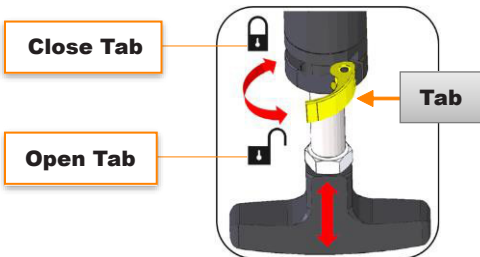

### TO ADJUST THE LENGTH OF THE HANDLE (FIGURE 20)

1. Open tab on Handle
2. Slide Handle up or down to desired length
3. Close tab on Handle

## Lock Docking Station on Boom Arm (All Models)

When the body shield is not in use during a procedure, it can be secured and stored using the docking station assembly on the boom arm. The assembly has a magnet, which holds the balancer and body shield in place, preventing unwanted sliding, drifting, along the boom.



### **Balancer Drift:**

*Boom arm is designed and installed with a 1° pitch that can result in drifting of the balancer. Use Docking Station to prevent unwanted drift.*

The docking station allows a storage location to be established. Verify that the body shield does not interfere with any other items when it is stored at the docking station.



*The Balancer tab **MUST** be on the side of the docking station with the magnet.*

Figure 21

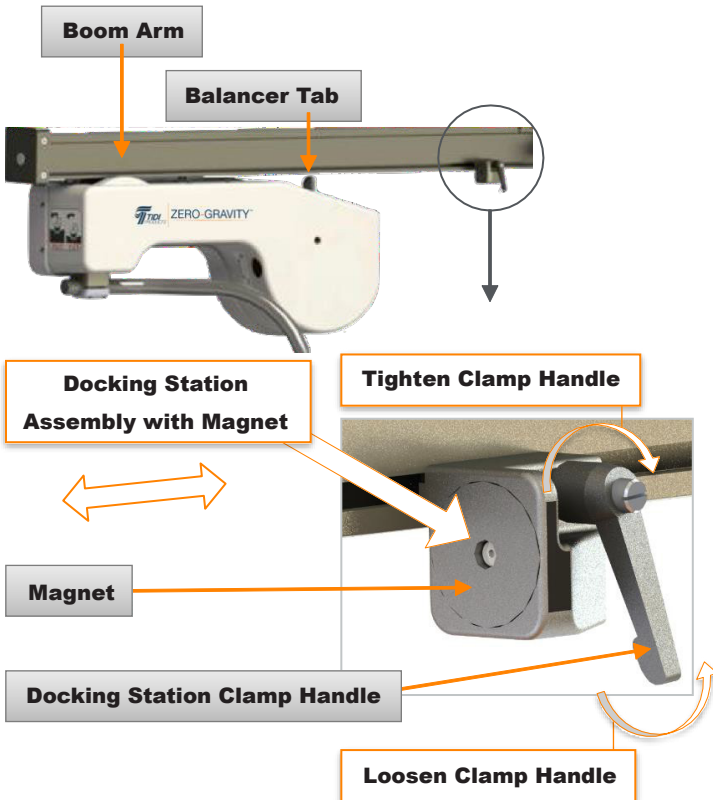

### TO LOCK THE BODY SHIELD IN PLACE (FIGURE 21)

1. Loosen docking station clamp handle and slide the assembly along boom to within 6 inches (15.2 centimeters) of the end.
2. Tighten clamp handle to lock docking station.
3. Slide the balancer and body shield toward the docking station until the magnet engages.
4. Test the placement, to ensure body shield rests in docking station. Adjust the docking station location as needed.

### TO UNDOCK THE BALANCER (FIGURE 21)

1. Pull Body Shield away until the Magnet disengages.



*If additional Trolley travel is needed, it may be necessary to rotate the Docking Station so that the Magnet is parallel to the ceiling.*

### TO ROTATE THE DOCKING STATION (FIGURE 21)

1. Loosen the Docking Station Clamp Handle.
2. Rotate the Docking Station so the Magnet faces the ceiling.
3. Tighten the Docking Station Clamp Handle.
4. Move the Trolley as needed.

## Secure the Body Shield (All Models)

Securing the Body Shield is useful for

- Storage when the Body Shield is not in use
- Steering the articulating arms in the room
- Putting a sterile cover on the Body Shield



**Use TIDI Products supplied sterile covers ONLY.**



**ZGM-6-5H:** Set the Vertical column to a height that will be comfortable for draping. Refer to positions A – F on the Column Height Label on the lower section of column assembly and Set the Height in this document.

The Balancer Connector has (2) posts and secures the Body Shield to the Balancer using slots inside the trolley Anti-Rotate Housing.

**Figure 22**

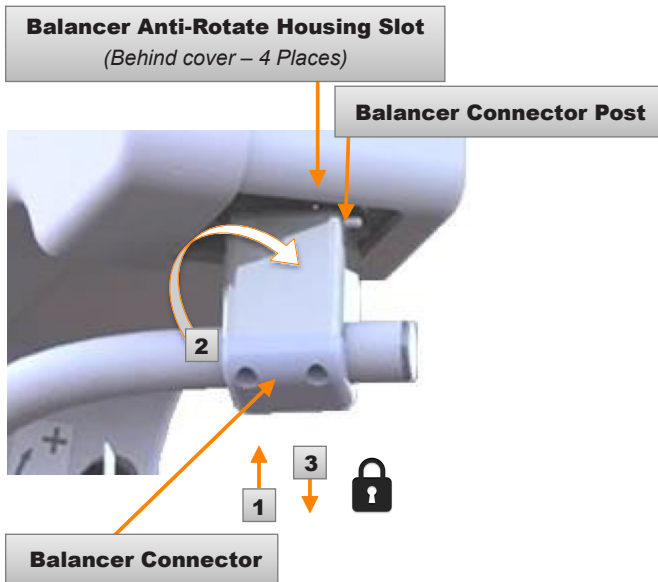

### TO SECURE THE BODY SHIELD INTO THE BALANCER (FIGURE 22)

1. Lift the Balancer Connector up into the Balancer Anti-Rotate Housing so that each Balancer Connector post seats into a slot in the Housing. Continue pushing the Connector up until the posts meet resistance in the slots.

2. Turn the Connector clockwise (to the right) until the posts meet resistance in the slots.
3. Pull the Connector down into the resting slot until the posts meet resistance.
4. Once secured, hold Body Shield by the frame (near the arm openings) and steer the unit into position.

Figure 23

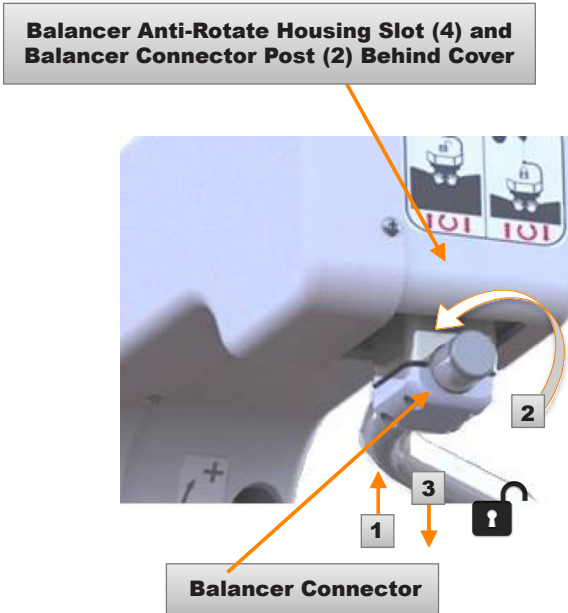

**TO ALLOW THE BODY SHIELD AND BALANCER CONNECTOR TO MOVE AS NEEDED FOR USE (FIGURE 23)**

1. Lift the Balancer Connector up out of the resting slot until the posts meet resistance.
2. Turn the Connector counterclockwise (to the left) until the posts meet resistance.
3. Lower the Connector out of the Balancer Anti-Rotate Housing so that Balancer Connector posts clear the slots in the Housing.

**The Body Shield is now suspended in “Zero Gravity”.**

## Put Sterile Cover on Body Shield (All Models)

Your system was delivered with a complimentary box of sterile covers. Cover the Body Shield according to the draping instruction enclosed in the provided packaging.

## Fit User Vest (All Models)



### Warning: Magnetic Field Hazard

#### CARDIAC DEVICE RISK

Zero-Gravity body shield connects magnetically to the vest and may cause a hazard with user defibrillators or pacemakers.

Vests are available in the following sizes: extra-small, small, medium, large, extra-large, triple extra-large. Note that the double extra-large size is not offered, as adjustment of extra-large or triple extra-large accommodates this size. (3) vests are included with the initial order. Additional vests may be ordered. Vests adjust to fit most body sizes and shapes. A surgical gown may be worn over the vest.

Figure 24



Vest Size	User Chest Girth (cm)
XS	71-132
S	84-145
M	93-154
L	97-159
XL	104-165
3XL	115-176

**TO PROPERLY FIT A VEST TO YOUR BODY (FIGURE 24):**

1. Select a vest closest to your shirt size.
2. With zipper in front, put on vest over your clothing and fully zip.
3. Adjust straps so vest is snug and connector is centered approximately heart high at sternum.
4. Secure all buckles.

**You are now ready to connect your vest to the body shield.**

**Adjust Body and Face Shield Height (All Models)**

Adjusting body shield up or down, as needed, allows maximum protection. Sides of the face shield should be at temple height (about at the top of the ears).



**WARNING! RADIATION EXPOSURE**

Failure to set body shield at the proper height, failure to use a vest, failure to couple vest to Body Shield, or failure to lower Shoulder Shields into position may cause excess body, cranium or lens radiation exposure. DO NOT expose unprotected back to radiation source!

*Figure 25*

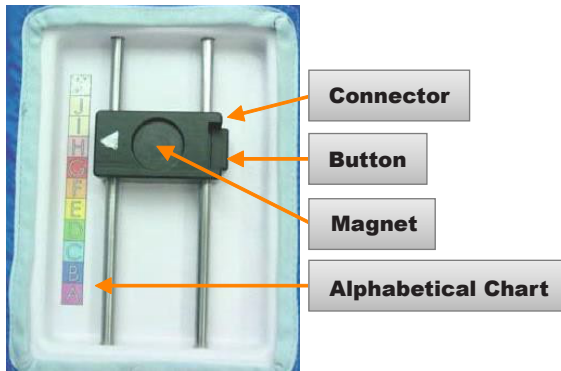

**TO ADJUST BODY SHIELD HEIGHT (FIGURE 25)**

1. Squeeze button and move Connector to adjust Body Shield height.
2. Release button when sides of Face Shield are at temple height (at the top of the ears).



*Lowering Connector raises the face shield, raising Connector lowers the face shield.*



*Locations are indicated on an alphabetical chart and settings can be written on the vest identification tag for each user.*

## Connect Vest to Body Shield (All Models)

The system must be sterile draped by a Zero-Gravity® brand drape, you must be wearing the Vest, and Shoulder Shields must be lowered prior to connecting Vest to Body Shield.

Figure 26

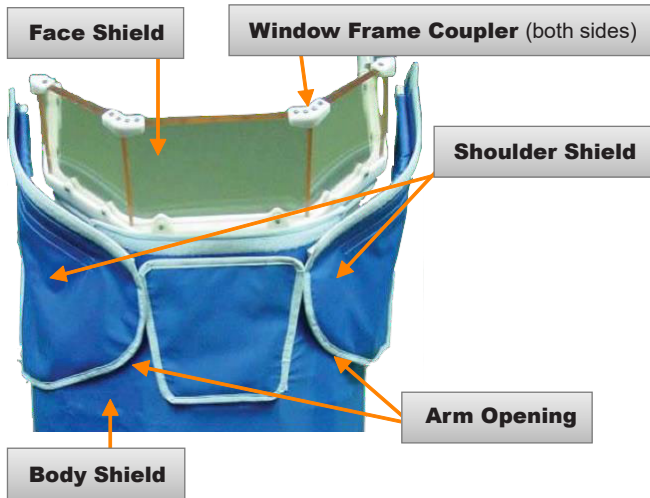

### TO CONNECT THE VEST AND THE BODY SHIELD (FIGURE 26)

1. Step into the body shield.
2. Extend your arms through the openings under Shoulder Shields.
3. Verify that Shoulder Shields are lowered, as shown in Figure 26.
4. Pull Body Shield toward you to allow Coupler on Vest to connect with Magnet on Body Shield.
5. There will be an audible snap as Vest Coupler attaches to Body Shield Magnet.
6. Gently bring your elbows toward your body, forming the shield to your body.

**Zero-Gravity is now ready for clinical use.**



## To Exit Body Shield (All Models)

Simply grasp body shield at arm openings and push outward.



*TIDI Products recommends that users perform the scanning procedure in the Body Shield and Face Shield Fluoroscopy Inspection section of this document to establish a baseline prior to using the Zero-Gravity.*



### WARNING! RADIATION HAZARD

Using a radiation source above the user, or directly in front (in the path of the Image Intensifier) of the user is NOT permitted.



### WARNING! INJURY RISK-CABLE HAZARD

Annual inspections must be performed on the cable. Cables must be replaced if there are signs of wear.

For systems manufactured before application of this guide:



### WARNING! INJURY RISK-CABLE HAZARD

Excessive rotation of Body Shield may cause Balancer Cable to break. The Body Shield must be lowered and allowed to unwind after each use, in an unlocked position. Annual inspections must be performed on the cable. Cables must be replaced if there are signs of wear.

## When Not in Use (All Models)

The Balancer and Body Shield may be moved to the parking location when not in use. The Body Shield may be stored in the Twist Lock feature. The Body Shield must be protected with a cover to prevent contamination.



### ***Take care to store the body shield so that:***

- There is no buckling or bending due to contact with other items or any components of the unit
- Shoulder shields are in operating position. See Figure 19.

## Disposal (All Models)

The Zero-Gravity Body and Face Shield have been designed for a 5-year lifetime, but the storage, use, and annual inspection will determine obsolescence and the need for disposal.

The Body Shield, Shoulder Shields, and Face Shield contain lead. The Body Shield Connector contains a rare earth magnet. Components containing lead or rare earth magnets must be disposed of in accordance with local, state, and federal regulations. The Zero-Gravity system should be disposed of in an environmentally safe manner.

## Other Useful Tips

---

### Moving the Floor Unit



**WARNING! TIP OVER HAZARD**

Lower assembly to lowest height prior to transport.



**WARNING! TIP OVER HAZARD**

To relocate device in surgical suite: raise leveling feet; roll over flat surfaces with no obstructions.



**CAUTION! PINCH POINT HAZARD**

Never push or pull Zero-Gravity base by placing hands on large D- shape plate. Casters may swivel and pinch hands or fingers. Always use lift handles to move Zero-Gravity system.



**WARNING! TRIP HAZARD**

After the system is relocated, reassembly includes leveling the Base according to Level the Base in this document. The Leveling Feet will be on the ground and the Leveling Foot Posts will be below the top surface of the Base.



**WARNING! RADIATION HAZARD**

The Body Shield must be handled with care to avoid damage to the Body Shield protective lead material. If the Body Shield is damaged, it must be inspected according to the Body Shield and Face Shield Fluoroscopy Inspection section of the User's Guide (TIDI Products document 84000).

### *Within the Surgical Suite or to Other Rooms*

The floor unit may be moved to other rooms if disassembly is not required. If disassembly is required, Contact TIDI Products service.

1. Raise leveling feet and unlock casters.
2. Carefully push base, using handles, over flat surface with no obstructions.
3. Level the Base according to this document.

## Cleaning the System

---

Zero-Gravity must be thoroughly cleaned and disinfected in accordance with standard operating room practices. Clean each component after use and prior to maintenance, as follows:

### Face Shield

#### Microfiber Towels With

- 70% isopropyl alcohol or
- Windex® Multi-Surface Antibacterial spray

#### ATTENTION



*The Face Shield will be immediately and permanently damaged if cleaned with abrasive cleaners. Do not use any of the cleaners listed in **DO NOT USE** (below) or your system will be damaged.*

#### NOTE



*When handling the Face Shield, only touch the Window Frame Couplers. Windows on the Body Shield are easily scratched (Figure 12).*

#### DO NOT USE

- Paper towels or linen washcloths
- Alcohol wipes - any brand
- CaviWipes™ or Sporidicin® Disinfectant Towelettes
- Rough or abrasive-faced sponges, brushes, cleaning pads, scrapers, or metal tools
- Strong detergents or abrasives such as scouring powders
- Aerosol cleaners with Butyl Cellosolve®
- Hydrocarbon or chlorinated solvents, ammonia, or strong alkali cleaners
- Cleaners that are designed for grease cutting
- Excessively hot water or steam

### Body Shield

- On fabric, use mild detergent, at manufacturer's recommended strength, in warm water.
- A 10% household chlorine bleach solution in warm water may be used for disinfection. Use only soft wiping materials.

### Vest

- Clean with mild detergent, at manufacturer's recommended strength, in warm water.
- A 10% household chlorine bleach solution in warm water may be used for disinfection. Use only soft wiping materials.
- Do not machine wash.

### Hardware

- Clean metal surfaces with mild detergent (such as Formula 409®), at manufacturer's recommended strength, in warm water.
- A 10% household chlorine bleach solution in warm water may be used for disinfection. Use only soft wiping materials. Never use rough or abrasive-faced sponges, steel wool, brushes, or cleaning pads.
- Never use scrapers or metal tools of any kind.

## Adjusting and Maintaining Zero-Gravity

### Adjust Balancer



The Balancer is adjusted at the factory. However, fine adjustments may rarely be required due to the Balancer spring relaxing.



Do not make adjustments unless the Body Shield and Shoulder Shields are installed.

### Balancer Safety

A spring balancer constantly applies ~ 54 pounds (24.5 kilograms) of force to balancer connector. The Body Shield hanging from this spring provides the weightless feature of this device.



#### WARNING! INJURY RISK-BALANCER

Balancer installation, service, and maintenance must be carried out by qualified personnel. These personnel should be alerted to the dangers associated with spring balancers. Spring balancers contain a spring under extreme force and can cause severe injury.

Figure 27

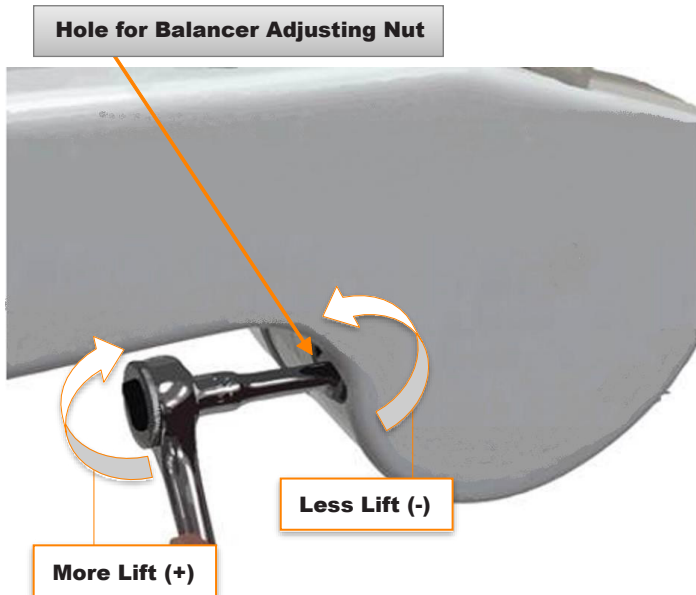

1. With Body Shield secured to Balancer cable, pull Body Shield down 6- 8 inches (15 – 20 centimeters) and release to test the balance. If Body Shield stays in position, no further action is required.



*If Body Shield drifts up or down, balancer needs further adjusting.*

2. With 17-millimeter socket, adjust Balancer by turning nut clockwise (+) for more lift and counterclockwise (-) for less lift (Figure 27).
3. Move Body Shield up and down several times allowing Balancer spring to adjust to new settings.

## Maintenance

The Zero-Gravity system requires annual preventative maintenance, inspection, and general cleaning throughout its life. Refer to the Zero-Gravity® Radiation Protection System preventative maintenance checklist (TIDI Products Document 81000) for preventative maintenance information.



*Contact a TIDI Products authorized representative or TIDI Products service if parts replacement or service are required.*



*Contact a TIDI Products authorized representative or TIDI service for additional information regarding preventative maintenance.*

## Body Shield and Face Shield Fluoroscopy Inspection

The Zero-Gravity Body Shield and Face Shield have been designed for a 5-year lifetime, but the storage, use, and annual inspection will determine obsolescence and the need for disposal.

Prior to use, the Body Shield and Face Shield should undergo a Fluoroscopy inspection, to ensure proper shielding. TIDI Products recommends that the facility follow their local scanning procedures.



Should the Body or Face Shield display any breaks or tears, replace the damaged item(s) immediately. The Body Shield, Shoulder Shields, and Face Shield contain lead and must be disposed of according to the Disposal section of this document.



### **WARNING! RADIATION HAZARD**

Stand clear of Fluoro beam path, keep hands and arms out of beam path.



Use caution when handling lead apron, make sure not to crease or fold any part, as it may result in damage to the lead shielding.

## Available Spare Parts and Accessories

Assembly instructions are included in either the Installation Guide or User's Guide. See the chart below.



### WARNING!

All replacement parts must be installed by a TIDI Products representative or a representative approved by TIDI Products.

Replacement Parts	Part Number	Instructions for Replacement
Complete Body Shield	ZGTBS	Installation Guide (TIDI Products Document 83000)
Body and Face Shield	ZGBFS	Installation Guide (TIDI Products Document 83000)
Body Shield Velcro Kit	ZGVRK-HOOK	Installation Work Instruction (TIDI Products Document 31644-302)
Face Shield	ZGFS	Installation Instruction (TIDI Products Document 31360)
Should Shields (Right and Left)	ZGSS-R OR ZGSS-L	Installation Guide (TIDI Products Document 83000)
Balancer	ZGLPB	Installation Guide (TIDI Products Document 83000)
Hinge Kit	31840 (after Oct 2018) or 31840-100 (before Oct 2018)	Installation Instructions (TIDI Products Document 44U00124)
Caster Replacement	40-3455	Installation Instructions (TIDI Products Document 29899-380)
Accessory	Part Number	Instructions for Use/Installation
Sterile Covers	ZGD20WA-LOOP	TIDI Products Document ZGD20WA-LOOP-300
Monorail Leaded Acrylic Shield	ZGCMRS	Installation Work Instruction and User's Guide (TIDI Products Document 32577)
Body Shield with Boom Arm 48 for Monorail	ZG48	Installation Guide (TIDI Products Document 83000)
Upgrade from Floor to Hybrid Monorail Design	ZGHH-CMHSA	Installation Guide (TIDI Products Document 83000)
Upgrade from Floor to Hinged Swing Arm	ZGHH-HSA	Installation Guide (TIDI Products Document 83000)
Upgrade Monorail 48/66 to Hybrid Monorail Design	ZGHH-66-CMHSA	Installation Guide (TIDI Products Document 83000)
Upgrade from Floor to 48" Hybrid Monorail Design	ZGHH-CM48	Installation Guide (TIDI Products Document 83000)

## Zero-Gravity® Radiation Protection System User's Guide

Accessory	Part Number	Instructions for Use/Installation
<b>Vests in sizes:</b>		
Extra-Small	ZGAV-XS	User's Guide (TIDI Products Document 84000)
Small	ZGAV-S	
Medium	ZGAV-M	
Large	ZGAV-L	
Extra-Large	ZGAV-XL	
Triple Extra-Large	ZGAV-3XL	

### Tool Pouch

If your Zero-Gravity requires replacement parts, a toolkit has been provided with the necessary tools to exchange parts.

The included tool pouch includes the tools listed below.

1. 17-millimeter-deep well socket, 12 point with 3/8-inch drive
2. 3-inch extension with 3/8-inch drive
3. 5/32-inch ball end hex key wrench
4. 3/8-inch square drive ratchet wrench

## Limited Warranty

---

TIDI Products warrants to Customer that this product, manufactured for TIDI Products and sold to customer, will be free from defects in materials and workmanship for a period of one (1) year after delivery to Customer. This warranty shall not apply to any products, which have been subjected to misuse, improper installation or repair, alteration, neglect, accident, abnormal conditions of operation, or use under conditions other than those for which the products were designed.

**EXCEPT FOR THE FOREGOING LIMITED WARRANTY, SELLER MAKES NO OTHER WARRANTIES, EITHER EXPRESSED OR IMPLIED, INCLUDING, WITHOUT LIMITATION, WARRANTIES OF FITNESS FOR A PARTICULAR PURPOSE OR OF MERCHANTABILITY.**

## Declarations of Conformity

---

The Zero-Gravity® Radiation Protection System Declarations of Conformity can be found at [www.tidiproducs.com](http://www.tidiproducs.com), and for additional information contact TIDI Products at 1.800.521.1314 or +1.920.751.4300.



**ATTENTION!**

**A USER GUIDE FINAL ACCEPTANCE** checklist is required as proof of system operational verification prior to clinical use.



*TIDI Products authorized personnel either maintains documentation of completion of in-service training or submits documentation to TIDI Products service.*

## Index of Additional System Labels

### Body Shield Labels

**TIDI** | ZERO-GRAVITY®

SCREW COVER SHIELD: Pb 1.00 / 150 kVp  
Zero-Gravity Screw Cover Shield, PIN ZGSCS  
\*IEC 61331-3:2014 (NARROW BEAM CONDITIONS) <https://www.tidiproducts.com/ifu>



(01)00618125190210(11)090122(10)123456  
78U00682 REV 00 ZGSCS-311-000

TIDI Products, LLC P. 1.800.621.1314  
570 Enterprise Drive P. +1.920.751.4300  
Neenah, WI 54956 WWW.TIDIPRODUCTS.COM  
USA 27U00121 REV 00 ZGSCS-310-000

UK CA0086  
CE 2797  
ANNEX II  
PPE REGULATION  
(EU) 2016/425  
ZGSCS-310-000

Screw Cover Shield System Label is used to define the Screw Cover:

- Cover (1.0) radiation protection in millimeters of lead equivalent per 150 kVp (Narrow Beam Conditions)
- Standards followed
- Contact information

**TIDI** | ZERO-GRAVITY®

SHOULDER SHIELD: Pb 1.00 / 150 kVp  
Zero-Gravity Shoulder Shield, Left, PIN ZGSS-L  
\*IEC 61331-3:2014 (NARROW BEAM CONDITIONS) <https://www.tidiproducts.com/ifu>



(01)00618125176267(11)090122(10)123456  
78U00590 REV 00 ZGSS-L-311-000

TIDI Products, LLC P. 1.800.621.1314  
570 Enterprise Drive P. +1.920.751.4300  
Neenah, WI 54956 WWW.TIDIPRODUCTS.COM  
USA 27U00119 REV 00 ZGSS-L-310-000

UK CA0086  
CE 2797  
ANNEX II  
PPE REGULATION  
(EU) 2016/425  
ZGSS-L-310-000

Shoulder Shield System Label is used to define the Left Shoulder Shield:

- Shoulder Shield (1.0) radiation protection in millimeters of lead equivalent per 150 kVp (Narrow Beam Conditions)
- Standards followed
- Contact information

**TIDI** | ZERO-GRAVITY®

SHOULDER SHIELD: Pb 1.00 / 150 kVp  
Zero-Gravity Shoulder Shield, Right, PIN ZGSS-R  
\*IEC 61331-3:2014 (NARROW BEAM CONDITIONS) <https://www.tidiproducts.com/ifu>



(01)00618125176274(11)090122(10)123456  
78U00049 REV 00 ZGSS-R-311-000

TIDI Products, LLC P. 1.800.621.1314  
570 Enterprise Drive P. +1.920.751.4300  
Neenah, WI 54956 WWW.TIDIPRODUCTS.COM  
USA 27U00118 REV 00 ZGSS-R-310-000

UK CA0086  
CE 2797  
ANNEX II  
PPE REGULATION  
(EU) 2016/425  
ZGSS-R-310-000

Shoulder Shield System Label is used to define the Right Shoulder Shield:

- Shoulder Shield (1.0) radiation protection in millimeters of lead equivalent per 150 kVp (Narrow Beam Conditions)
- Standards followed
- Contact information

## Vest Labels

### ZERO-GRAVITY® VEST

NAME:

SIZE: EXTRA SMALL  
PART # ZGAV-XS

<https://www.tidiproducts.com/tf>



(01)00618125176106(11)090122(10)123456  
7BU00051 REV 00 ZGAV-XS-311-000

 TIDI Products, LLC P. 1.800.521.1314  
570 Enterprise Drive P. 1.920.751.4300  
Neenah, WI 54956 www.tidiproducts.com  
USA 27U00112 REV 00

  
UK  
CE 2797  
ANNEX II  
PPE REGULATION  
(EU) 2016/425  
ZGAV-XS-310-000

Write name of user on label.

Size **Extra Small**

Replacement Part Number:  
**ZGAV-XS**

Contact Information  
Standards followed

### ZERO-GRAVITY® VEST

NAME:

SIZE: SMALL  
PART # ZGAV-S

<https://www.tidiproducts.com/tf>



(01)00618125176083(11)090122(10)123456  
7BU00043 REV 00 ZGAV-S-311-000

 TIDI Products, LLC P. 1.800.521.1314  
570 Enterprise Drive P. 1.920.751.4300  
Neenah, WI 54956 www.tidiproducts.com  
USA 27U00113 REV 00

  
UK  
CE 2797  
ANNEX II  
PPE REGULATION  
(EU) 2016/425  
ZGAV-S-310-000

Write name of user on label.

Size **Small**

Replacement Part Number:  
**ZGAV-S**

Contact Information  
Standards followed

### ZERO-GRAVITY® VEST

NAME:

SIZE: MEDIUM  
PART # ZGAV-M

<https://www.tidiproducts.com/tf>



(01)00618125176076(11)090122(10)123456  
7BU00044 REV 00 ZGAV-M-311-000

 TIDI Products, LLC P. 1.800.521.1314  
570 Enterprise Drive P. 1.920.751.4300  
Neenah, WI 54956 www.tidiproducts.com  
USA 27U00114 REV 00

  
UK  
CE 2797  
ANNEX II  
PPE REGULATION  
(EU) 2016/425  
ZGAV-M-310-000

Write name of user on label.

Size **Medium**

Replacement Part Number:  
**ZGAV-M**

Contact Information  
Standards followed

### ZERO-GRAVITY® VEST

NAME:

SIZE: LARGE  
PART # ZGAV-L

<https://www.tidiproducts.com/tf>



(01)00618125176069(11)090122(10)123456  
7BU00045 REV 00 ZGAV-L-311-000

 TIDI Products, LLC P. 1.800.521.1314  
570 Enterprise Drive P. 1.920.751.4300  
Neenah, WI 54956 www.tidiproducts.com  
USA 27U00115 REV 00

  
UK  
CE 2797  
ANNEX II  
PPE REGULATION  
(EU) 2016/425  
ZGAV-L-310-000

Write name of user on label.

Size **Large**

Replacement Part Number:  
**ZGAV-L**

Contact Information  
Standards followed

### ZERO-GRAVITY® VEST

NAME:

SIZE: XL  
PART # ZGAV-XL

<https://www.tidiproducts.com/tf>



(01)00618125176090(11)090122(10)123456  
7BU00046 REV 00 ZGAV-XL-311-000

 TIDI Products, LLC P. 1.800.521.1314  
570 Enterprise Drive P. 1.920.751.4300  
Neenah, WI 54956 www.tidiproducts.com  
USA 27U00116 REV 00

  
UK  
CE 2797  
ANNEX II  
PPE REGULATION  
(EU) 2016/425  
ZGAV-XL-310-000

Write name of user on label.

Size **Extra Large**



Replacement Part Number:  
**ZGAV-XL**

Contact Information  
Standards followed

## Vest Labels (cont.)

 | **ZERO-GRAVITY® VEST**

**NAME:** \_\_\_\_\_

**SIZE:** 3XL  

**PART #** ZGAV-3XL <https://www.tidiproducts.com/tvu>



(01)00618125176120(11)090122(10)123456  
7BU0048 REV 00 ZGAV-3XL-311-000

 DO NOT  
MACHINE  
WASH

**UK**  
**CA0086**

**CE** 2797  
ANNEX II,  
PPE REGULATION  
(EU) 2016/425

**ZGAV-3XL-310-000**

 TIDI Products, LLC P. 1.800.621.1314  
570 Enterprise Drive P. 1.920.781.4300  
Neenah, WI 54956 www.tidiproducts.com  
USA 27U00117 REV 00

Write name of user on label.

Size **3 Extra Large**

Replacement Part Number:  
**ZGAV-3XL**

Contact Information  
Standards followed

**THIS PAGE IS INTENTIONALLY LEFT BLANK**

## User's Guide Final Acceptance

---

### NOTE: THIS IS SHEET 1 OF A 3-SHEET FORM

I hereby certify that customer in-service training has been provided and understood for each of the following topics:

- Overview of Zero-Gravity system.
- Review of key operational characteristics:
  - Provides radiation exposure protection to frontal and side radiation exposure protection to Proximal Arm, Axilla, Torso, Gonads, Lower extremity down to Proximal Tibia (on taller users), Neck and Cranium when set to correct height.
  - Body shield is sterile when properly draped by a Zero-Gravity® brand drape.
  - Balancer, rotational bearings, and Boom operate freely and smoothly throughout range of motion.
  - Balancer vertical travel operates freely and smoothly throughout range of motion.
  - Body Shield does not drift up or down when balanced.
  - Body Shield and operator maintain connection during use.
  - Body Shield easily locks and unlocks to balancer to steer during positioning.
- Putting on the Vest, adjusting the Straps, and placing the Connector centered approximately heart high, at the Sternum.
- Setting the height of the Body-Shield Connector, recording custom height for each user on the Vest identification tag.
- Connecting to the Body Shield. Warnings about magnetic field hazards.
- Demonstration on a two-person Sterile Draping procedure. Exiting and re-entering the Body Shield.

**NOTE: THIS IS SHEET 2 OF A 3-SHEET FORM**

**Evaluating Workflow**

**Is the range of motion installed for the Zero-Gravity to:**

- Access one side of the table.
- Access both sides of the table.
- Identify the parking and storage locations.

**Identify the overhead magnetic Docking Station:**

- In-use location (next to table).
- Storage location (away from table).
- Placed upside down for additional working length.
- Identify all potential work flow collisions and avoidances.
  - Warnings about radiation to:
  - Set height of Body Shield at the temple (top of the ears).
  - Use a Vest.
  - Connect to Body Shield.
  - Lower Shoulder Shields.
  - Do not turn back to radiation source.
  - Do not place radiation source above the user, or directly in front of the user (in the path of the image intensifier).
- Using Swivel and lock features.
- Adjusting Balancer.
- Using "Twist and Lock" feature for draping and steering the double articulating arm.
- Cleaning instruction for Face Shield to avoid damage.
- Cleaning instruction for Body Shield.
- Review Annual inspection requirements with service personnel.
- Review the importance of Annual inspection of Cable with service personnel.
- Body Shield and Face Shield Fluoroscopy.
- Users Guide review.
- Return (3) pages of Final Acceptance forms to TIDI Products.

## Zero-Gravity® Radiation Protection System User's Guide

**NOTE: THIS IS SHEET 3 OF A 3-SHEET FORM**

**Part #:** \_\_\_\_\_

**Model Description:** \_\_\_\_\_

**Serial #:** \_\_\_\_\_

**Other:** \_\_\_\_\_

**Facility Name:** \_\_\_\_\_

**Installation Address:** \_\_\_\_\_

I, \_\_\_\_\_,  
TIDI Products-authorized trainer, hereby certify that necessary in-service training has been  
conducted and understood.

I, \_\_\_\_\_, (name of facility representative)

\_\_\_\_\_, (title of facility representative)

Equipment/Application/System is functionally acceptable at the current time.

**Trainer Signature:** \_\_\_\_\_

**Trainer Name:** \_\_\_\_\_

**Date of Acceptance:** \_\_\_\_\_

**Telephone:** \_\_\_\_\_

**Trainer Email Address:** \_\_\_\_\_

\_\_\_\_\_  
Facility Representative Signature

\_\_\_\_\_  
Date

\_\_\_\_\_  
Facility Representative Name



**THIS PAGE IS INTENTIONALLY LEFT BLANK**

## User's Guide Review

---

Users must be properly trained prior to use of this product on the following topics:

- Overview of Zero-Gravity system.
- Review of key operational characteristics:
  - Provides radiation exposure protection to frontal and side radiation exposure protection to Proximal Arm, Axilla, Torso, Gonads, Lower extremity down to Proximal Tibia (on taller users), Neck and Cranium when set to correct height.
  - Body shield is sterile when properly draped by a Zero- Gravity® brand drape.
  - Balancer, Body Shield, bearings, and Boom operate freely and smoothly throughout range of motion.
  - Balancer vertical travel operates freely and smoothly throughout range of motion.
  - Body Shield does not drift up or down when balanced.
  - Body Shield and operator maintain connection during use.
  - Body Shield easily locks and unlocks to balancer to steer during positioning.
- Putting on the Vest, adjusting the Straps, and placing the Connector centered approximately heart high, at the Sternum.
- Setting the height of the Body-Shield Connector, recording custom height for each user on the Vest identification tag.
- Connecting to the Body-Shield.
- Warnings about magnetic field hazards.
- Demonstration on a two-person Sterile Draping procedure.
- Exiting and re-entering the Body Shield.
- Evaluating Work flow
  - Is the range of motion installed for the Zero-Gravity to:
    - Access one side of the table.
    - Access both sides of the table.
  - Identify the parking and storage locations.
  - Identify the overhead magnetic Docking Station:
    - In-use location (next to table).
    - Storage location (away from table).
    - Placed upside down for additional working length.
  - Identify all potential work flow collisions and avoidances.
  - Warnings about radiation to:
    - Set height of Body Shield at the temple (top of the ears).
    - Use a Vest.
    - Connect to Body Shield.
    - Lower shoulder shields.
    - Do not turn back to radiation source.
    - Do not place radiation source above user, or directly in front of the user (in the path of the image intensifier).
- Using Swivel and Lock features.
- Adjusting Balancer.
- Using "Twist and Lock" feature for draping and steering the double articulating arm.
- Cleaning instruction for Face Shield to avoid damage.

- Cleaning instruction for Body Shield.
- Review Annual inspection requirements with service personnel.
- Review the importance of Annual inspection of Cable with service personnel.
- Body Shield and Face Shield Fluoroscopy Inspection.
- Users guide review.

For additional training on your Zero-Gravity, contact TIDI Products at:

Phone: 1.800.521.1314  
+1.920.751.4300

**THIS PAGE IS INTENTIONALLY LEFT BLANK**

**THIS PAGE IS INTENTIONALLY LEFT BLANK**

**THIS PAGE IS INTENTIONALLY LEFT BLANK**

Manufactured for:



Made in the  
United States of America

**CONTACT INFORMATION**

Phone: 1.800.521.1314  
+1.920.751.4300

United States Patents  
7,973,299; 8,207,516;  
8,558,204; 8,598,554 B2;  
8,925,553; 8,933,426  
For U.S. and Foreign Patent  
information, see  
[//go.tidiproducts.com/patents](http://go.tidiproducts.com/patents)  
Additional Patents Pending